

LOUGHBOROUGH
UNIVERSITY OF TECHNOLOGY
LIBRARY

AUTHOR/FILING TITLE

GOODSON, A D

ACCESSION/COPY NO.

03372702

VOL. NO.

CLASS MARK

5 JUL 1991	LOAN COPY
-2 JUL 1993	15 DEC 1995
	22 MAR 1998
	26 APR 1996
-2 JUL 1993	
-9 NOV 1995	24 MAR 1999
9 JUL 1995	26 APR 1999

LB 0033727023



A MULTI-MODE SONAR TRANSMITTER

by

Anthony David Goodson

A Masters Thesis submitted in partial fulfilment of the requirements for the award of Master of Philosophy of the University of Technology, Loughborough, England.

August 1989

Department of Electronic and Electrical Engineering.
Loughborough University of Technology.

© by Anthony David Goodson, 1989.

Loughborough University of Technology Library	
Date	Oct 90
Class	
Acc No.	03372702

Y931 7313

Acknowledgements.

I would like to express my thanks to the following:

First to Professor Roy Griffiths who, in guiding the Sonar Research Group activity, has provided an unfailing source of ideas.

Funding for this work was provided by the Ministry of Defence (Procurement Executive) through the Admiralty Research Establishment Teddington. Contract No.D/ER1/9/4/2170/0104.

To Dr.J.Cook of ARE for arranging access to the trials facilities on the Admiralty Acoustic Ranges and for his support during the discussion of ideas and the evaluation of the results. Derek White and Tony Dicker of ARE for arranging the logistic support and instrumentation recordings of the sea trials. The practical assistance from the ARE Technical Support Group at Lochgoil while conducting these was particularly appreciated.

The Severn Trent Water Authority for permission to use the South Derbyshire reservoirs at Melbourne and Foremark.

Mike Large and the Area District Controllers:

Dai Davies, Allan Bird and Douglas Ball.

The Water Bailiffs at Foremark:

Peter Harrison and Colin Lawrenson.

To my colleagues at Loughborough University who have been involved in various aspects of this work at different times and particularly to those who shared in the winter measurement trials including:

Dorothy Anne Lees and Keith Lowe.

Avtar Gida, Bill Wood, Phil Hill and David Payne.

Technicians, Gary Wagg et al. who helped deploy and recover the equipment at Foremark.

Ian Sinclair and Dr.Bryan Woodward for diving support during investigation and redeployment of targets in Foremark.

Roger Mayo and colleagues in the Civil Engineering Department for survey work at Foremark and for the subsequent sub-surface computer terrain modelling.

Anthony David Goodson August 1989.

A MULTI-MODE SONAR TRANSMITTER.

Abstract

This project was initiated to evaluate appropriate microprocessor and digital logic techniques that could increase the flexibility and effectiveness of a sonar transmitter. The study led to a multi-channel signal synthesis concept designed to exploit 'phased array' steering techniques. Two versions of the equipment have now been built and evaluated. Mk.1 is a relatively low power 15 channel system with 2 kilowatts total electrical power using a 40 kHz $15 \lambda \times 1$ line array. This system proved the practicability of the basic concept and its success led to the 16 kilowatt Mk.2 high power version which drives a $16 \lambda \times 16 \lambda$ wideband transducer array.

The study included:

The design and construction of a multi-channel signal generator.

The writing of control and signal synthesis software.

The design, evaluation and commissioning of suitable linear power amplifiers .

Investigations into suitable transducers and phased array design, leading to the manufacture of suitable matched wideband multi-channel 'staved' transducer arrays.

Finally, a series of trials were made in a variety of open water conditions to evaluate the systems performance and investigate the multiple modes of operation that have been developed.

The system has successfully demonstrated that transmitter beam steering is both practical and flexible. The techniques implemented permit sector interrogation by 'within-pulse' type sweeps, by 'Ripple-fire' and by transmitting steered 'Pings' sequentially on predetermined bearings. Each mode allows considerable flexibility in the generated waveform shape and frequency.

The 'Multi-Mode' capability of this approach was conceived primarily as a research tool but many of the modes can be isolated and exploited in dedicated applications.

A MULTI-MODE SONAR TRANSMITTER

by A.D.Goodson

CONTENTS.

Acknowledgements.	.	.	.	i.
Abstract.	.	.	.	ii.
Contents	.	.	.	iii
GLOSSARY				
Lists of Symbols	.	.	.	vi.
List of Figures.	.	.	.	viii.
Chapter 1 INTRODUCTION.				
1.0 Sonar Transmitter Evolution.	.	.	.	1.
1.1 Transmitter Driver Technologies.	.	.	.	2.
1.2 Signal Waveform Synthesis.	.	.	.	3.
1.3 Design Objectives.	.	.	.	4.
Chapter 2 MODES OF OPERATION.				
2.0 Introducing the Multi-Mode Concept.	.	.	.	6.
2.1 Steered beams.	.	.	.	9.
2.2 Ripple fire.	.	.	.	13.
2.3 Swept 'within-pulse' transmissions.	.	.	.	13.
2.4 Focussing.	.	.	.	16.
2.5 Sidelobe Shading.	.	.	.	18.
2.6 High Power Non-Linear Operation.	.	.	.	19.
2.7 Bearing Coded Transmissions.	.	.	.	20.
2.8 Test Signals.	.	.	.	22.
Chapter 3 HARDWARE.				
3.0 Hardware Introduction.	.	.	.	25.
3.1 Micro-Computer.	.	.	.	25.

3.2	MOSFET Power Amplifiers.	. . .	29.
3.3	High Power Linear Amplifiers.	. . .	30.
3.4	Power Amplifier Performance Summary.	. . .	35.
3.5	Transducers and Arrays.	. . .	38.
3.6	Wide Band Transducer Elements.	. . .	39.
3.7	High Power 256 Element Array.	. . .	41.
3.8	Mk.2. Array Tests.	. . .	45.
3.9	Mk.2.Array Parameter Summary	. . .	47.

Chapter 4 SOFTWARE.

4.0	Software Introduction.	. . .	48.
4.1	Languages. Z80 Assembler / Basic / Pascal.	. . .	48.
4.2	System Software.	. . .	50.
4.3	Program Example - Data Synthesis.	. . .	51.
4.4	Program Example - Data Handling and Control.	. . .	54.
4.5	Summary of Software used for Lochgoil Trials.	. . .	57.

Chapter 5 DATA ACQUISITION.

5.0	Acoustic Measurement and Trials Range Facilities.	. . .	60.
5.1	Loughborough University's Acoustic Test Tank.	. . .	61.
5.2	King George VI Reservoir, Staines.	. . .	62.
5.3	Foremark Reservoir, Derbyshire.	. . .	62.
5.4	Maytime, Lochgoil, Argyle.	. . .	66.
5.5	Sonar Receivers.	. . .	68.
5.6	Hydrophones and Preamplifiers.	. . .	68.
5.7	Data Logging and Signal Analysis Equipment.	. . .	69.

Chapter 6 TRIALS RESULTS.

6.0	Initial System Tests - Beam forming and Focussing.	. . .	71.
6.1	Beam Forming and Shading.	. . .	74.
6.2	Beam Steering.	. . .	76.
6.3	Sector Scanning - Ripplefire and Sweep Modes.	. . .	78.
6.4	Source Levels and Non-Linear Acoustics.	. . .	80.
6.5	Source Level Results.	. . .	82.
6.6	Reference target detection - Foremark.	. . .	83.

Chapter 7 CONCLUSIONS & DISCUSSION.

7.0	Objectives and Conclusions.	85.
7.1	The Advantages of a Multi-Mode System.	86.
7.2	General Discussion.	87.
7.3	System Reliability.	88.
7.4	Improving Hydrophone Data Acquisition.	89.
7.5	Future developments.	90.

REFERENCES.

List of References.	93.
-----------------------------	-----

APPENDICES.

I	Drawings and Circuit diagrams.
II	The LUTEE Beam Plotter.
III	Program Software Listings.

GLOSSARY

0.1 LIST of SYMBOLS and ABBREVIATIONS

A/D	Analogue to Digital conversion.
ALS	Advanced Low power Schottky Logic. e.g.74ALS00.
ARE	Admiralty Research Establishment.
ARE(T)	ARE(Teddington),
ARE(P)	ARE(Portland),
ARE(LG)	ARE(Lochgoil).
Bt	Byte. - 8 bit word.
k	kilo = 10^3
kbt	kilobyte. - 1024 bytes. or \$400 (Hexadecimal) bytes
CMOS	Complementary Metal Oxide Silicon (Field effect transistors and logic elements.)
CPM	8080 and Z80 micro-computer disk operating system. Digital Research Trademark. CP/M.
dB	deciBel
D/A	Digital to Analogue conversion.
DSP	Digital Signal Processor. - A specialised microprocessor with an architecture optimised for very fast multiplication, data manipulation and transfer. e.g.TMS320c25 or MC56000.
EPROM	Electrically Programmable Read Only Memory.
FFT	Fast Fourier Transform.
LS	Low power Schottky Logic. - e.g. 74LS00
HCT	High Speed CMOS logic. - e.g. 74HCT244 .
LUT	Loughborough University of Technology,
LUTEE	Electronic & Electrical Engineering Department at LUT.
MOSFET	Metal Oxide Silicon Field Effect Transistor.
NLA	Non Linear Acoustics - Parametric Sonar.
OEM	Original Equipment Manufacturer.
P	Pascal. ISO unit of pressure.
μ P	micro-Pascal.

PIO	Parallel In/Out - Microprocessor peripheral. communication port - Dual 8 bit parallel data.
Q	Quality factor of a resonant network. Usually expressed as the ratio of Centre Frequency to Bandwidth.
ROV	Remotely Operated Vehicle. Small submersible vehicle carrying instrumentation, TV cameras etc., used for inspection work especially where divers would be at risk. Usually controlled from the surface by an umbilical cable.
RISC	Reduced Instruction Set Computer.
RAM	Random Access Memory.
ROM	Read Only Memory.
TTL	Transistor Transistor Logic Family.
UART	Universal Asynchronous Receiver Transmitter. Serial data communication port device.

Greek symbol usage.

λ	lambda = one wavelength.
μ	mu = micro = 10^{-6} .
π	Pi = 3.141592654 or computed from $4 * \text{Atn}(1)$.
θ	Theta = Angle of propagating wavefront to array face.
ω	$2\pi f$ = Angular frequency.
ψ	Psi = Inter-element phase shift in array.

LIST OF FIGURES

- 2.0/1 Beam Steering Diagram
- 2.0/2 15 element point source array 1 lambda pitch.
- 2.0/3 Predicted response of array based on actual dimensions.
- 2.0/4 Predicted response of array in phase steered increments.
- 2.0/5 Block diagram of RAM buffers and Host computer memory map.
- 2.1/1 RAM Buffer contents unsteered 0°.
- 2.1/2 RAM Buffer contents steered 2°.
- 2.1/3 RAM Buffer contents steered 4°.
- 2.2/1 Ripple fire timing skew across the sector.
- 2.3/1 Swept pulse across sector.
- 2.3/2 Buffer contents - 1 millisecond sweep - 1st part.
- 2.3/3 Buffer contents - 1 millisecond sweep - 2nd part.
- 2.3/4 Hydrophone response to a sweep signal.
- 2.4/1 Buffer contents 9 metre focus.
- 2.4/2 Buffer contents 2 metre focus.
- 2.4/3 Buffer contents 1 metre focus.
- 2.7/1 Three contiguous sweep transmissions, (1+5+1 milisecs)
- 2.7/2 Hydrophone response on 0° axis
- 2.7/3 Hydrophone response on +24° axis.
- 2.8/1 Test signal - channel alignment - misaligned.
- 2.8/2 Test signal - channel alignment - adjusted.
- 2.8/3 Test signal - 36-50 kHz multiburst.

- 3.2/1 Mk.1 transmitter assembly.
- 3.3/1 The laboratory prototype 2 x 1 kilowatt Amplifier
- 3.3/2 Prototype amplifier full power output, +/- 70 volt supply rails.
- 3.3/3 Prototype amplifier output with raised supply rails, +/- 80 volts.
- 3.3/4 Production Design Amplifier at full power.
- 3.4/1 Frequency response of the complete Mk.2 high power system including the power amplifiers and transducer.
- 3.4/2 The Mk.2 transmitter assembly.
- 3.5/1 Transducer Array - construction detail.

- 3.5/2 15 element Mk.1 Array.
- 3.6/1 I.O.S Transducer element construction.
- 3.6/2 Universal Sonar Ltd. - Mk.2. Wideband transducer.
- 3.7/1 Mk.2. Dual array being deployed at Foremark reservoir.
- 3.8/1 Multiburst test signal - Full 256 element array.
- 3.8/2 Multiburst test signal - First 128 element half array.
- 3.8/3 Multiburst test signal - Second 128 element half array.
- 3.8/4 Beam plot of the full array at 42 kHz.
- 3.8/5 Beam plot of the first half array.
- 3.8/6 Beam plot of the second half array.
- 3.8/7 Foremark Reservoir Lakebed - Mechanical scan -6 degrees tilt.
- 3.8/8 Foremark Reservoir Lakebed - 800 metre sector.

- 5.1/1 LUTEE Acoustic test tank.
- 5.2/1 Trials Facility at Staines Reservoir. - Hydrophone support deployed.
- 5.3/1 Foremark Reservoir and Draw Tower.
- 5.3/2 Foremark - Outer working platform with array support etc.
- 5.3/3 Foremark - Underwater Computed Terrain Model.
- 5.4/1 Maytime Acoustic Range Facility in Lochgoil.
- 5.4/2 Lochgoil - Computed Terrain Model viewed from transducer position.
- 5.4/3 Lochgoil Modelled with 50 metres of water removed.

- 6.0/1 Beamplotting arrangements at Staines.
- 6.0/2 Mk.1.Array Beam Plot, 200 degree scan.
- 6.0/3 Mk.1.Array Beam Plot, 40 degree scan.
- 6.0/4 Beam Plot at 2 metres range. Inside the near field.
- 6.0/5 Beam Plot at 2 metres range. Focussed data.
- 6.1/1 Theoretical Beam Pattern of a 15 element 1 lambda pitch array.
- 6.1/2 Theoretical pattern with Dolph-Chebychev shading (20:1).
- 6.1/3 Mk.1 Array plot - Unshaded 38 kHz.
- 6.1/4 Mk.1 Array plot - Dolph-Chebychev shaded.
- 6.1/5 Theoretical pattern with array phase errors added.
- 6.1/6 Theoretical pattern with phase errors and Dolph-Chebychev shading.
- 6.2/1 Beam Plot - Mk.2 Array - 8° steered data - log plot.
- 6.2/2 Beam Plot - Mk.2 Array - 15° steered data.
- 6.2/3 Beam Plot - Mk.2 Array - 28° steered data.

- 6.3/1 Beam Plot - Ripplefire Transmission.
- 6.3/2 Hydrophone response to a 4 x 1 ms Sweep Pattern.
- 6.3/3 Hydrophone response to a 7 ms Sweep pattern.
- 6.3/4 7 ms Sweep - Hydrophone placed 30^o off-axis.
- 6.4/1 NLA transmission spectrum.
- 6.4/2 Foremark NLA beamwidth.
- 6.6/1 Mid-water -18 dB reference target.
- 6.6/2 Reference Target echo - 0 degrees tilt.
- 6.6/3 Reference Target multiple echoes.
- 6.6/4 Reference Target - Bottom reverberation 2 degrees tilt.

A MULTI-MODE SONAR TRANSMITTER

Chapter 1 INTRODUCTION.

1.0 Sonar Transmitter Evolution.

Techniques for Sound Navigation and Ranging are usually referred to by the acronym SONAR a name originated by the American Navy during the Second World War. In recent years the term has acquired a generalised usage referring to all forms of acoustic target location, including passive detection systems and is occasionally used when referring to underwater communications. In this study the unqualified term SONAR will be restricted to mean active echolocation systems.

All sonar echolocation systems comprise:

A transmit signal synthesiser to define the waveform, duration and frequency of the transmission.

A transmit transducer assembly to couple the drive signal into the water and create the required acoustic pressure waves.

A receive transducer to convert the incident echo energy back into electrical signals.

A receiver amplifier and signal processing system to detect and convert target echo signals into a form which can be presented to the operator for interpretation. Most modern systems present the echo information using cathode ray tube (CRT) displays although paper printouts are still in common use for echosounders and side-scan sonars.

In many systems a single transducer array is used for both transmission and reception and this is switched between the signal processing electronics as required.

Most commercial sonar systems use a single channel transmitter and the associated receiver either exploits the vessels forward movement as a scanning axis (Side-scan) or, if the transducer is rotatable, may scan mechanically by transmitting on adjacent bearings progressively across a sector. The more sophisticated 'within pulse' sector scanning systems use a multichannel receiving transducer and employ modulation techniques¹ to scan a sector. For each time resolvable range 'cell', as the transmit pulse propagates, the

receiver direction of maximum sensitivity is scanned across the sector to determine the bearing of target echoes within the cell. This process is repeated continuously and generates a range / bearing 'raster' display of the full sector for each transmit inter-pulse period. Military and commercial systems utilising 'within pulse' scanning include Plessey's Type 193 mine hunting sonar and the Marconi Hydrosearch equipment. The circuit complexity of such receivers is very high and it is only in recent years that the use of digital synthesis has successfully simplified this technique,². To date the concept of phase steering the transmitted beam pattern does not seem to have attracted much support, probably a direct economic consequence of increased circuit and array complexity. The advantages of such techniques in the electromagnetic spectrum,³ are well established and are exploited in the elevation scanning mode of a number of modern 'phased array' radars. e.g. Marconi 'Martello', Plessey AR-320 and ITT's 'Gilfillian' etc.,⁴. Theoretically it is feasible to exploit similar phase steering techniques in a sonar transmitter system. In water the low propagation velocity of the acoustic wave provides a significant time 'window' between transmissions, a parameter not easily exploited in radar. The steady increases in computational speeds of digital signal processors seems likely to encourage the development of adaptive techniques in which echo responses can be used to define the subsequent transmission. The design of a sonar transmitter with controlled inertia free beam steering and flexible waveform synthesis is a step towards this objective.

This project implements an azimuth steered phased array sonar transmitter, based on micro-computer techniques, and evaluates the system performance in a variety of operational modes.

1.1 Transmitter Driver Technologies.

Many technologies have been employed to generate high acoustic source levels in the water to insonify potential targets ranging from explosive charges, electro-magnetic 'boomer's, capacitive discharge 'sparkers' to the use of compressed air driven mechanisms. However, for the majority of sonar applications, systems which drive a piezo-electric or magneto-strictive transducers have remained the most adaptable. Electrical signal synthesis techniques for these transducers have evolved from the long lived 'tone wheel' interrupters used in the World War II type 144 ASDIC to the

electronic oscillator and power amplifier which displaced them by the mid 1950's

Thermionic valve power amplifier designs must now be regarded as obsolete. The bi-polar transistor, which finally replaced the valve for power amplification applications, now competes with a range of power MOSFET devices which already threaten to supercede them for many applications. Most modern sonar transmitters are built using transistor switching techniques which offer excellent power efficiency but frequently generate coarsely 'quantised' waveforms which necessitate narrow band filtering in the final coupling stage if unwanted modes of vibration are not to be excited within the transducer.

Linear power amplification was selected for this project, primarily to maintain the system bandwidth, as the possible use of the system with widely different frequency transducer arrays was considered likely. Advantages were also foreseen for a system which could exploit wideband transmissions with defined amplitude characteristics. These ideas required initial investigations into power amplification techniques using MOSFETs and led to the commissioning of some useful, Kilowatt rated, sonar amplifier modules, ⁵.

1.2 Signal Waveform Synthesis.

During the late 1970's investigations into suitable bi-polar designs for high power sonar transducer drivers explored and exploited digital logic techniques to simplify the control, frequency generation and synthesis of the drive waveform. This research at Loughborough, ^{6 - 7}, led to the development of a family of efficient 'switched mode' power transmitters operating at frequencies up to 300 kHz and at peak power levels approaching 20 kilowatts. The gated pulse train of these transmitters were typically adjustable between 50-200 microsecond pulses with repetition rates between 0.25 and 1 second. The waveforms were very coarsely synthesised 2 bit resolution 'sine' waves (three amplitude levels) which necessitated sharply tuned coupling transformers. These transmitters were designed primarily for use with scanning sonar receivers and were successfully applied at frequencies down to 40 kHz. and many of the units constructed are still in use, ⁸. Dedicated transmitter designs where the frequency is crystal derived to match a specific transducer and which utilise highly tuned output transformers to filter the coarsely stepped drive waveforms are inflexible devices when an operational

choice of arrays is needed or when broad band signals for correlation applications are required. These design limitations resulted in suggestions that a modern microprocessor controlled frequency synthesis approach should offer a more flexible alternative.

This project was initiated with an investigation of available frequency synthesiser techniques which might simplify the generation of precise signal frequencies to suit alternative transducer arrays. The results of this investigation indicated that synthesis using a simple 8 bit microcomputer could be both cost effective and flexible. If a relatively large number of digital samples are computed for each waveform cycle, then the need for high 'Q' band limiting filtering to smooth the resulting analogue signal is removed and the phase and amplitude of the signal can be defined accurately and repeatably. The use of a dedicated microprocessor, running a control program reading waveform codes stored in memory, is a cost effective alternative to the hard wired logic of earlier transmitters.

To exploit the possibilities of this approach fully, more operator interaction is required, which necessitates a keyboard and visual display unit. The consequent increased equipment cost has fortunately been matched by the rapid reduction in costs of the small mass produced 'single board' micro-computer.

1.3 Design Objectives

Traditional sonar transmitter designs are dedicated pieces of hardware with relatively rigid parameters. A simple transducer replacement often requiring internal modifications, i.e. a change of output filter and the crystal reference. In modern sonar equipment the generation of the transmit waveform has already moved away from gated analogue techniques towards the digital synthesis domain. Computer logic elements have simplified the pulse timing and analogue output signals derived from D/A conversion are now common place, often deriving the signal parameters from a PROM 'look-up' table. The direct computation of the waveform using a microprocessor is a logical development and the synthesis of multiple phased related signals has been examined. Exploiting microprocessor techniques to replace hard wired logic permits a signal synthesiser design to add considerable flexibility through software, offering both standardisation and simplification of the electronic hardware. This project was initiated, after an investigation into

microcomputer signal synthesis demonstrated that computation of the signal waveform could be a very flexible tool. Establishing the feasibility of extending such micro-computer signal generation to control and exploit a multichannel transducer array as a steerable 'phased' array sonar is therefore the main objective. It was recognised at the start that a single 8 bit micro-processor's computational speed would limit the direct synthesis concept to very low frequency multi-channel applications. While a multiple processor approach is considered feasible, the technique exploited separates the waveform synthesis computation from the transmission in order to achieve realistic operating frequencies with a minimum of complexity. The synthesised multichannel waveforms, pre-calculated 'off-line' are stored for fast simultaneous access in parallel digital RAM buffers,⁹

This technique has now evolved into a self contained microcomputer controlled 'multi-mode' sonar transmitter driving a multichannel transducer array, the combination of which permits a large number of operational modes to be evaluated. Two practical systems have been developed; Mk.1. a relatively low power 2 kilowatt 15 channel configuration and Mk.2. a much higher power 16 kilowatt system intended to extend the techniques into non-linear sonar research. The further development of this high power transmitter into the non-linear operational modes is on-going research and some initial encouraging results have been published in recent conference papers,^{10 -11}.

A MULTI-MODE SONAR TRANSMITTER

Chapter 2 MODES of OPERATION.

2.0 Introducing the multi-mode concept

A sonar transmitter capable of producing several simultaneous phase related signals can be used to drive a multi-element transducer array to inject phase related acoustic signals into the water from different positions distributed along the array. The interaction of the resultant individual wave fronts can be exploited to generate a coherent response which can be steered in a desired direction. If all the transducer channels are driven with identical signal data then the array will form its main directivity 'lobe' along the axis perpendicular to the array face. This 'broadside' response typifies most transducer array applications where a single signal source drives all the array elements in parallel. If the array is subdivided into individual elements or 'staves', then the application of a uniform progressive phase shift to each elements' driving signal will cause the principal lobe to be formed and propagated off-axis. The amount of angular shift obtained being a function of the array element spacing and the relative phasing of the drive signals.

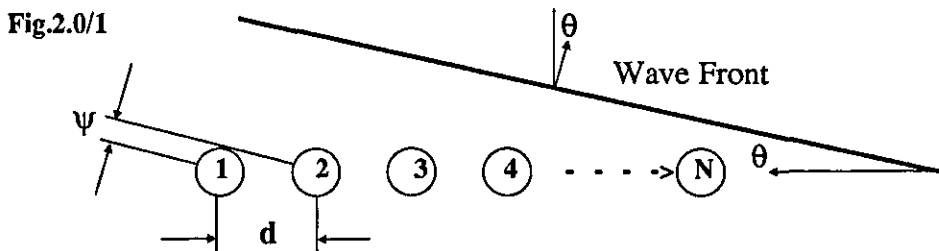

For beam steering ¹, consider an array of N equally spaced elements, (Fig.2.0/1). The spacing between each element is d and the signals at each element are assumed to be of equal amplitude. If the same phase is applied to all elements, the relative phase difference between adjacent elements is zero and the position of the main beam will be broadside to the array at an angle $\theta = 0$. The main beam will point in a direction other than broadside if the relative phase difference between the elements, ψ , is other than zero.

The direction of the main beam is at an angle θ_0 when the phase difference is

$$\psi = 2 * \pi (d / \lambda) \sin \theta_0$$

The phase at each element is therefore

$$\psi_c + \mu\psi, \text{ where } \mu = 0,1,2, \dots,(N - 1),$$

and ψ_c is any constant phase applied to all elements.

The normalised radiation pattern of the array when the phase difference between adjacent elements is ψ is given by

$$G_0 = \frac{\sin^2 [N * \pi (d / \lambda) (\sin \theta - \sin \theta_0)]}{N^2 * \sin^2 [\pi (d / \lambda) (\sin \theta - \sin \theta_0)]}$$

The maximum of the radiation pattern occurs when $\sin \theta = \sin \theta_0$

The Mk.1.'multi-mode' system was constructed with the exploration of phased array techniques as one of the prime objectives. This equipment initially used a single line array comprising 15 sandwich transducers equally pitched at 40 mm spacing with a centre frequency of 39 KHz. The use of a one lambda pitch array can be shown to produce not only the required 'broad-side' response but an additional significant 'endfire' mode. Utilising these array dimensions, computer modelling techniques were employed to establish the theoretical directivity pattern and to predict the modified response produced by the circular transducer piston heads, (fig.s 2.0/2 & 3). The computed patterns demonstrate that the unwanted 'endfire' component is reduced significantly in practice by a shading factor defined by the transducer elements finite dimensions, (0.95 λ diameter), In freshwater, assuming $c=1460$ m/s, the model predicts that the 'endfire' grating lobe will be shifted from 90 degrees towards 75 degrees off axis when all the elements are fed with the same phase, (1.04 λ inter-element pitch). The effect was observed to occur during the reservoir trials. Computer modelling also demonstrates that a lambda pitch array can be phase steered through an angle of one radian. At deflected angles of plus or minus a half radian from the centre axis the diffraction secondary lobe will be equal in amplitude to the steered main lobe and this defines the useable scanned sector. This grating lobe can be shown to be generated from the phase shifted 'endfire' response. At this maximum steered angle the symmetrical dual lobes will generate ambiguous echo responses from targets at either edge of the sector. Since the array response

Fig.2.0 / 2

- a) A 15 element point source array with a 1λ inter-element pitch.
- b) Directivity pattern of a circular piston transducer 0.95λ diameter.
- c) Response of a 15 element transducer modified by the individual element responses.

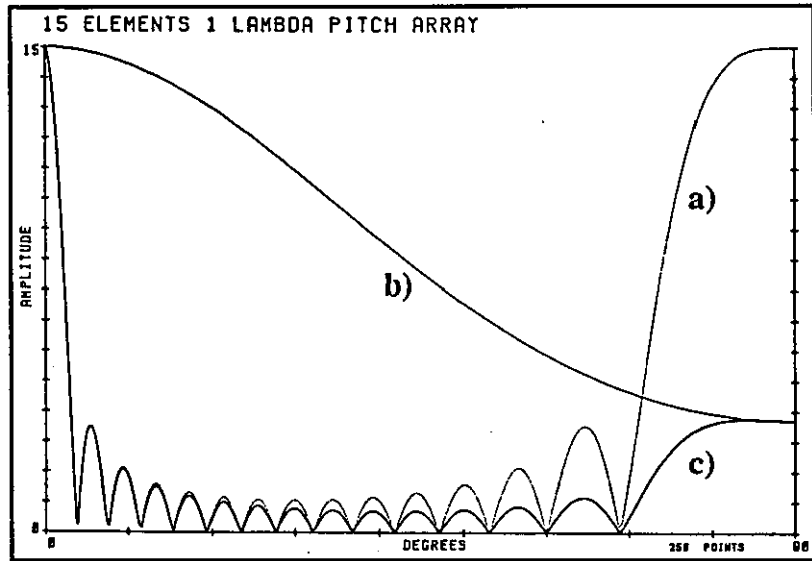

Fig.2.0 / 3.

Predicted response of a 15 element array using real dimensions. Piston diam. = 38 mm. Centre freq. = 39 kHz. 40 mm inter-element pitch. Calculated for seawater. Note, The shifted diffraction secondary at endfire.

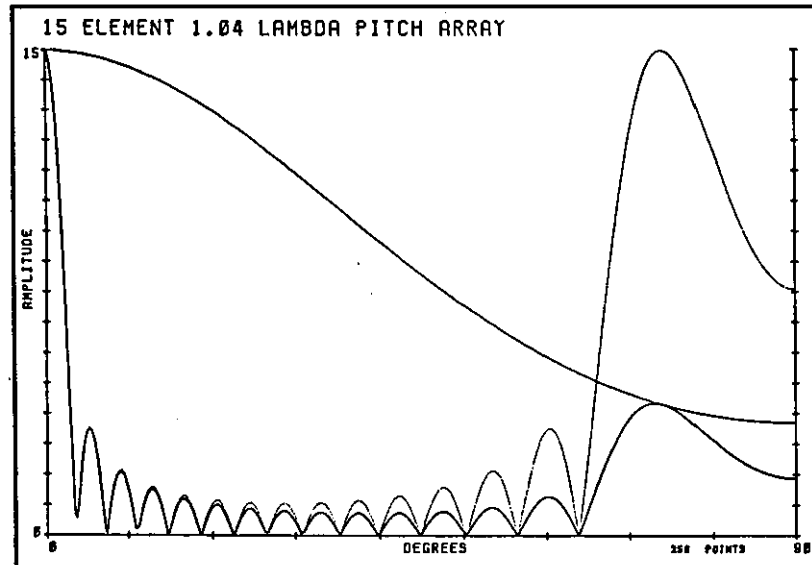
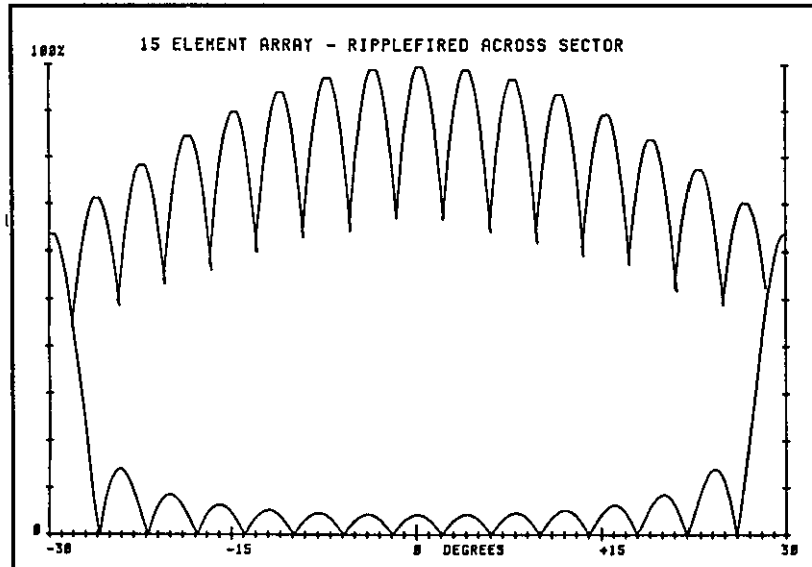

Fig.2.0 / 4.

Computed plot of a 15 element 1λ pitch array. Phase Steered 0.5 radians off axis to demonstrate the equal amplitude diffraction lobes.

The plot also includes an overlay of the peak responses produced by a set of steered data files, demonstrating the Ripple fire response.



using real elements with directivity can be shown to be the point source diffraction pattern multiplied by that of the individual element, the peak amplitude response as the array steers off axis will be progressively reduced, (fig.2.0/4). This theoretical plot includes an overlay of 16 phase steered beams whose peak amplitudes reflect the effect of the individual elements' directivity. The pattern generated by these peak responses simulates the effect of a sector scanning 'ripplefire' transmission.

To implement these theoretical predictions the necessary phase related drive waveforms are calculated digitally and stored in parallel sets of auxiliary RAM buffers, (fig.2.0/5). These RAM memory buffers co-exist as 'read only' data banks outside the micro-computer's memory map, and are accessed simultaneously by a programmable read control card at transmission time. The read control card, functioning from control parameters stored in latches, clocks out the data samples into parallel sets of D/A converters and the resulting phase locked analogue signals are amplified and used to drive the transducer staves. The host micro-computer accepts parameters from the operator console and programs the control card to implement them. During the file transfer process data from disk is first loaded into a scratch pad area at \$8000-8FFF in the microcomputer memory. This temporary area is required while demultiplexing the block file into 16 channels. Each buffer memory card is sequentially enabled, in parallel with main memory, while the copy process takes place. There are some areas of contention in the computer memory map which need protecting, specifically the dynamic stack created during program execution by the Pascal language. This stack exists below \$D000 and as a result access to \$C000-CFFF in the auxiliary buffers is restricted. These buffer addresses are utilised by mapping ROM test signal data which are therefore available at all times.

The remaining accessible 20 kilobytes of each buffer permits data for a large number of alternative modes to be called from disk and stored ready for immediate transmission.

2.1 Steered Beams.

The data required to generate CW pulses on any bearing is minimal. Only a single cycle needs to be defined, appropriately phase shifted in each channel, together with an arrangement to repeat this data as necessary to establish the required pulse length. In practice oversampling the waveform will

Fig.2.0/5 Block Diagram of the Auxiliary Memory Buffers and the Host Microcomputer Memory Map.

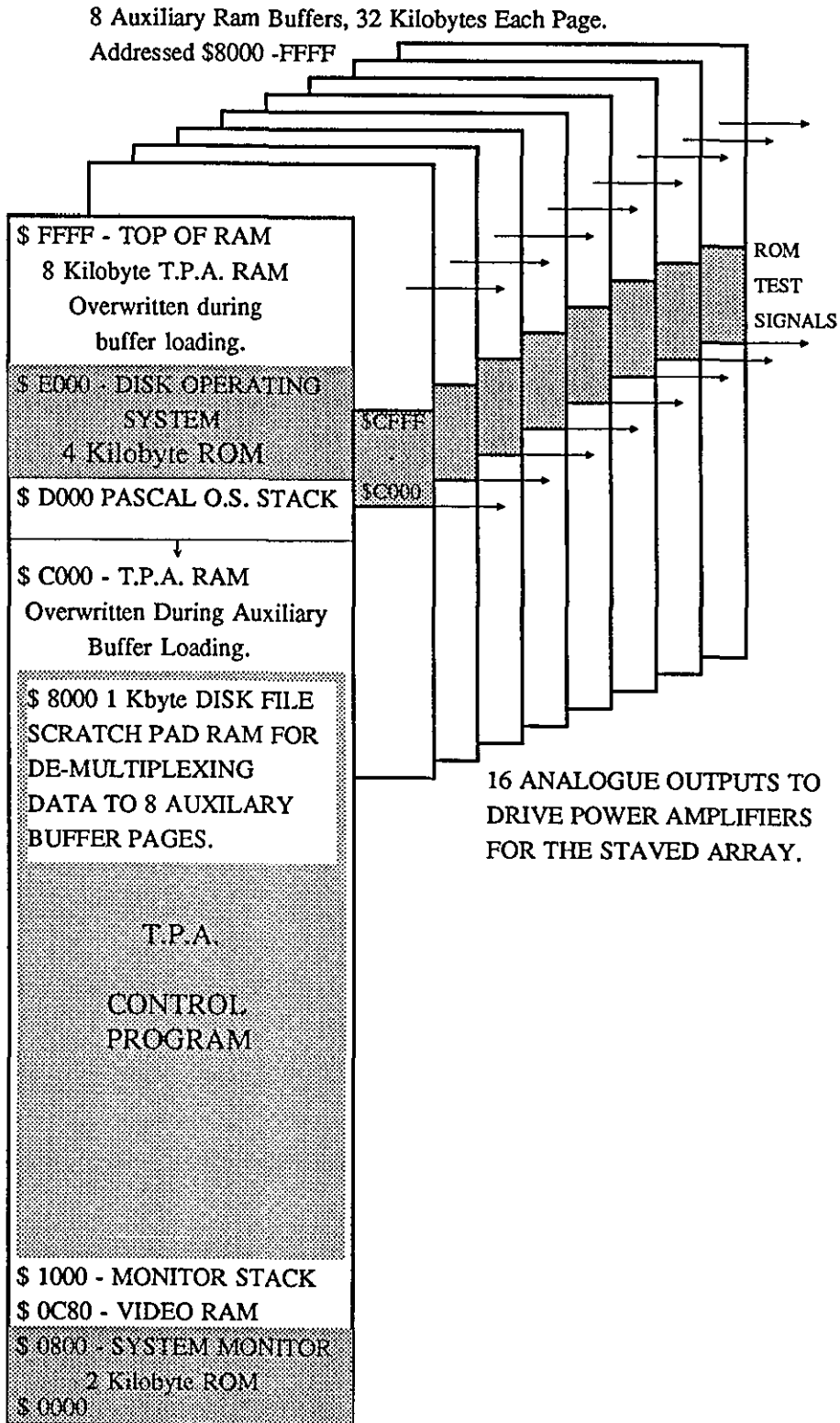

reduce the filtering requirements and at 40 KHz it has proved convenient to sample at 500 KHz. A block of data containing 256 samples (100 Hexadecimal) has proved easy to manipulate and can contain several complete cycles of the carrier data. To establish a transmit pulse of given duration this block of data needs to be recirculated, which implies that the data pulse length will be incremented block length steps, (0.512 millisecs increments). The sample block must contain an integer number of carrier cycles if a repeating phase shift 'glitch' in the transmission is not to occur at the block boundary. As the length of the data block in circulation can be adjusted to any number of samples (1-255) the block technique does not restrict precise frequency generation, provided that the frequency of the waveform data is the same for each channel. Beam steering becomes possible by 'rotating' the waveform data within the block, by an appropriate number of clock cycles, to generate the progressive phase shifts required to beam steer in a specific direction. Long pulses are constructed from up to 256 repeated block lengths (131 millisecs). The system was originally intended to synthesise a maximum pulse length of 100 milliseconds.

This economical use of buffer memory permits the stacking of 16 sets of bearing data in a 1000 Hex 'stack'. The discrete bearings stored in individual 'blocks' within this stack can then be re-addressed instantly, enabling very flexible beam switching to 'interrogate' selected parts of a 60 degree sector. For pulses longer than 131 milliseconds the contents of the stacked memory can be transmitted contiguously, i.e. as each block of data completes its programmed recirculation the transmission continues using the next block in the stack until all the blocks have been utilised.

This technique provides for either a very long pulse of 2 seconds maximum duration (16 x 131 millisecs) or, for unique data that cannot be recirculated, a maximum pulse length of 8 milliseconds.

Specific data for regular usage, e.g. the steered channel data, can optionally be stored in EPROMs for dedicated applications and, as these fixed buffers can be located at different memory addresses from the RAM 'scratch pad' versions, they can be utilised without the mode change delays involved in disk data transfer. Currently this ROM technique is employed to hold the channel comparison test signals which are required for alignment and fault diagnostics.

Fig.2.1/1

UNSTEERED DATA

Beam forms on the array axis.
Display of channel phasing created by program DISPLAYf.
First and last stored cycles in the 256 byte buffer.
Note. Data is normally output from right to left.

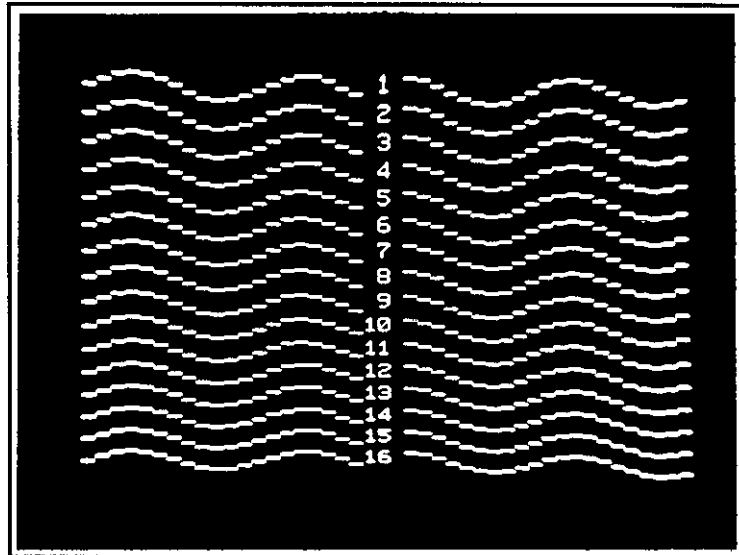

Fig.2.1/2

STEERED DATA

Beam forms 2° off the centre axis.

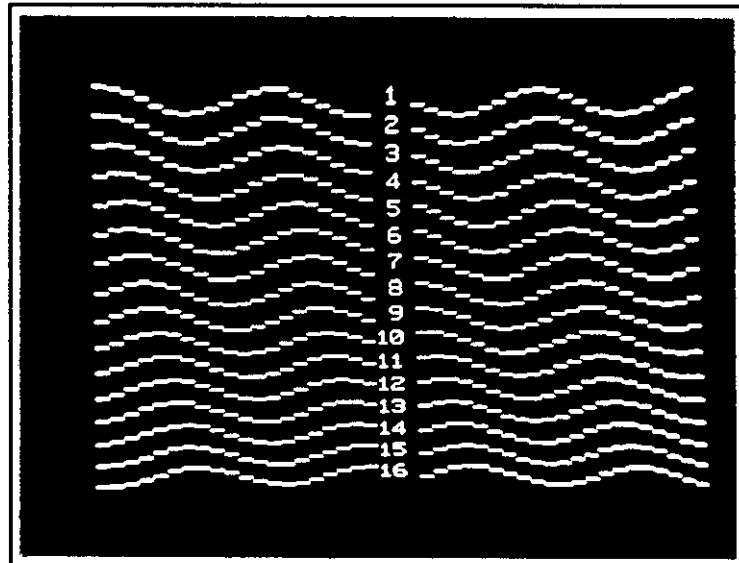
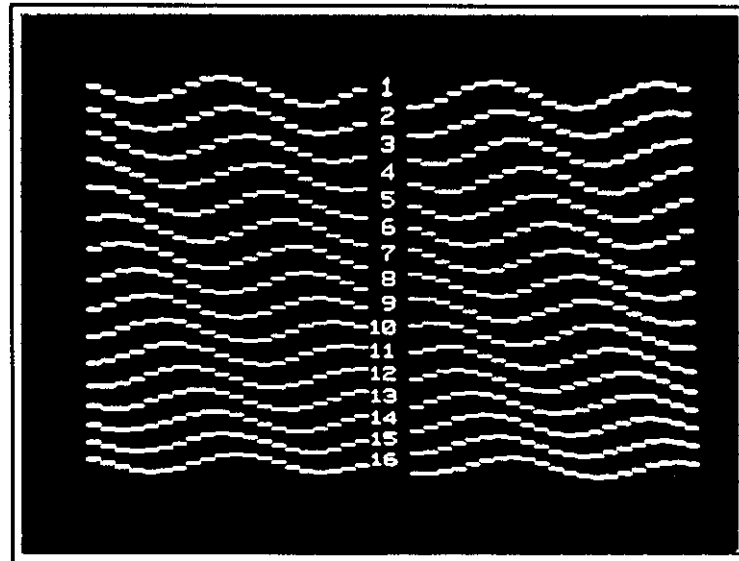

Fig.2.1/3

STEERED DATA

Beam forms 4° off the centre axis.



The test program, DISPLAYf, accesses the precomputed stored data to enable a visual display of the 16 relative phases using the first and last few cycles in each block of the output memory buffer, (figs.2.1/1,2,3 - Note. the program displays the data transmission starting on the right \$FF and proceeding to the left \$00). These three examples demonstrate the progressive phase shifts needed to phase steer the sonar beam off axis in 2 degree increments, i.e. these are from a data set restricted to steer across a 30 degree sector. The beam width, formed by the array, is 4 degrees so this data set will over-illuminate the sector. Examples of actual beam patterns plotted from these phase steered transmissions are included in chapter 6.

2.2 Ripple fire.

This application uses the full set of steered bearing data blocks, with each bearing selected sequentially and transmitted as part of a contiguous bearing pulse. The sonar beam forms at one end of the sector and 'ripples' across the sector in discrete steps. The technique is efficient in insonifying the sector as the full intensity of the narrow formed beam falls on each part in turn. The bearing steps within the transmission must be a compromise between overlapping patterns, to avoid missing targets, and the total pulse duration. An unavoidable timing 'skew' across the sector occurs as a result of the contiguous transmission (fig.2.2/1). An example of the composite beam pattern that results from a ripple fire transmission is plotted in chapter 6. The technique offers some operational advantages in reverberant conditions, as once a target is localised, the insonified sector can be narrowed by switching to alternative sector data held in adjacent parts of the buffer. Ripple sector data for 60, 30 and 15 degree sectors have been generated and used.

2.3 Swept 'Within-Pulse' Transmissions.

The swept beam is a simple extension of the ripple fire mode. The beam forms at one edge of the sector and steers smoothly across the sector during the pulse, (fig.2.3/1). The full energy from the defined narrow beam insonifies every part of the sector in turn. This mode mirrors the function of a sector scanning receiver although there are some important differences to be recognised.

A scanning receiver array receives target echoes generated from a pulsed single frequency narrow fractional bandwidth transmission and can

Fig.2.2/1 Ripple Fire Mode, Contiguous Pulses propagate across the sector with an incremental delay determined by the pulse lengths.

RIPPLE FIRE TRANSMISSION

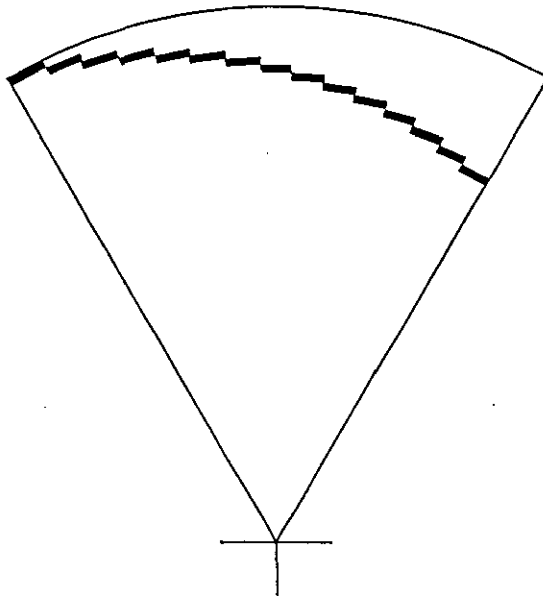

Fig.2.3/1 Sweep Sector Transmission, a 'within pulse' scan of sector.

SWEPT PULSE

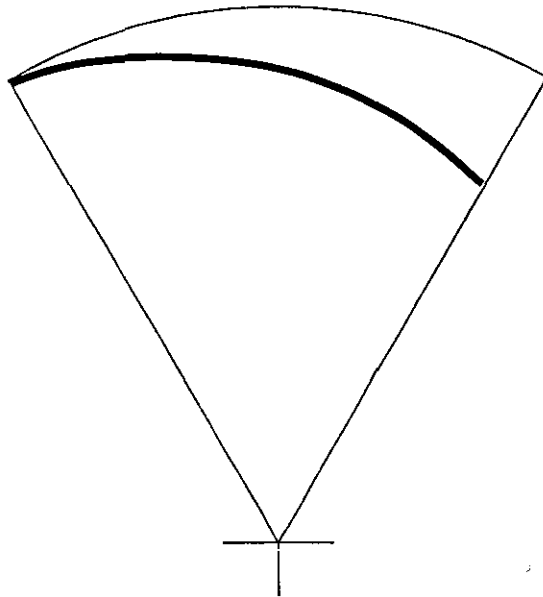

Fig.2.3 / 2.

One millisecond sweep

First half millisecond data block

Signals start 180° out of phase (on the right) at buffer address, \$A1FF, and progress to become in phase by the end of the block, \$A100. i.e. The steered beam is now pointing on axis.

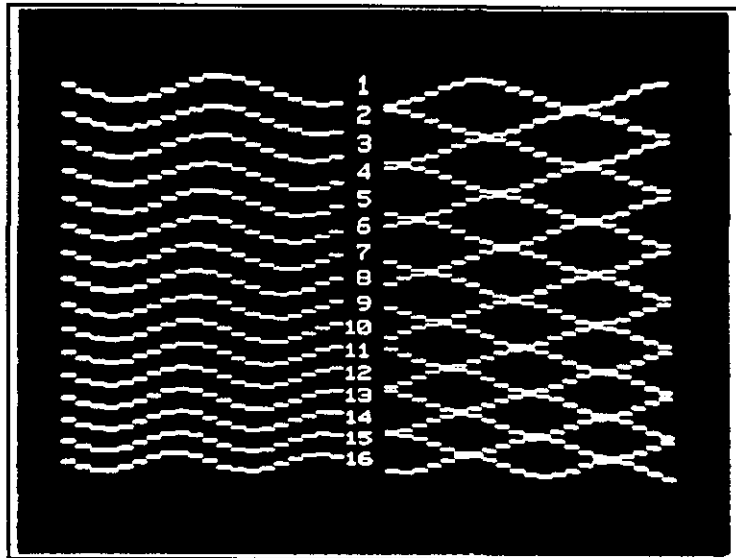

Fig.2.3 / 3.

One millisecond Sweep

Second half millisecond data block.

The 16 data channels continue the progressive phase change until the resulting beam is steered to the far edge of sector.

Buffer \$A00FF-\$A000. Note. Each channel transmits a different frequency.

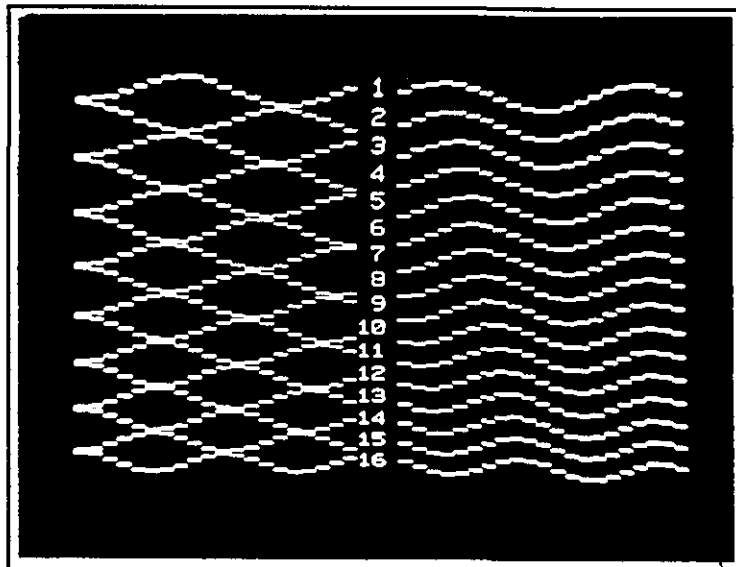
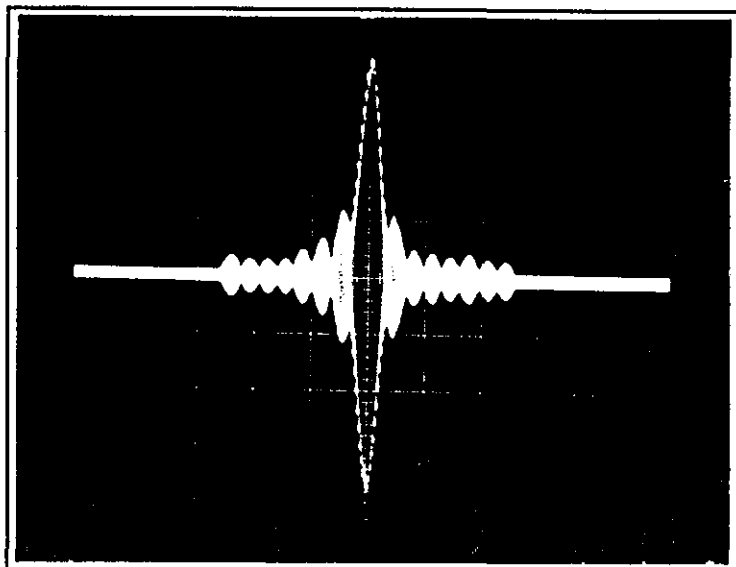

Fig.2.3 / 4.

Hydrophone Response

A hydrophone deployed on axis and in the far field responds to the beam pattern of the array when swept by the electronically steered transmission.



use an array of identical relatively high 'Q' transducers. The scanning of the direction of maximum sensitivity being achieved by signal processing within the receiver electronics.

A swept beam transmitter scans its narrow sonar beam across the sector by injecting a set of closely spaced frequencies into the water along the array face. Each transducer transmits a frequency differing from its neighboring element by the sweep rate. The technique demands a low 'Q' transducer to ensure adequate bandwidth to accommodate the frequency span determined by the sweep rate. The transducer element bandwidth therefore defines the maximum sweep rate. This swept sector application is restricted by the length of the available buffer stack. As each channel differs in frequency the block contents are unique to specific parts of the swept sector, i.e. repeating a block from the stack would re-scan that segment. The maximum length of a swept pulse cannot exceed 8 milliseconds with the hardware of the data buffers currently configured as 16 x 256 samples. (Clocked at 500 kHz). However this permits 500 microsecond insonification of each point target in the sector and at 40 kHz has been found satisfactory. Shorter pulses are easily defined and a one millisecond sweep takes two blocks of the stack. The block contents displayed in figure 2.3/2 demonstrate that the signals in adjacent channels start 180 degrees out of phase, i.e the beam is steered from the sector edge and progresses until the channels are all in phase at the end of the first block, at this point the beam will be formed on the centre axis, and as it continues through the second block (fig.2.3/3), the phase differences progressively increase steering the beam towards the other edge of the sector.

A hydrophone placed on the centre axis and insonified by this signal mode will detect the array beam pattern as its response, (fig.2.3/4).

2.4 Focussing.

The distance from the array at which the beam pattern is fully formed, i.e. its far field pattern, becomes inconveniently large with increasing array size and higher frequencies. Using a positive focus acoustic lens in front of the array can effectively reduce the length of the nearfield. Examples of this technique are not commonly found in sonar systems although the converse effect has been employed to synthesise a curved radiator from a flat array². by defocussing the array with an acoustic lens³. However with a multichannel system similar effects can also be achieved by re-phasing the data

Fig.2.4 / 1.

9 Metre Focussed Data

Data buffer display of contents, unsteered, with a small focussing correction applied progressively towards the ends of the array.

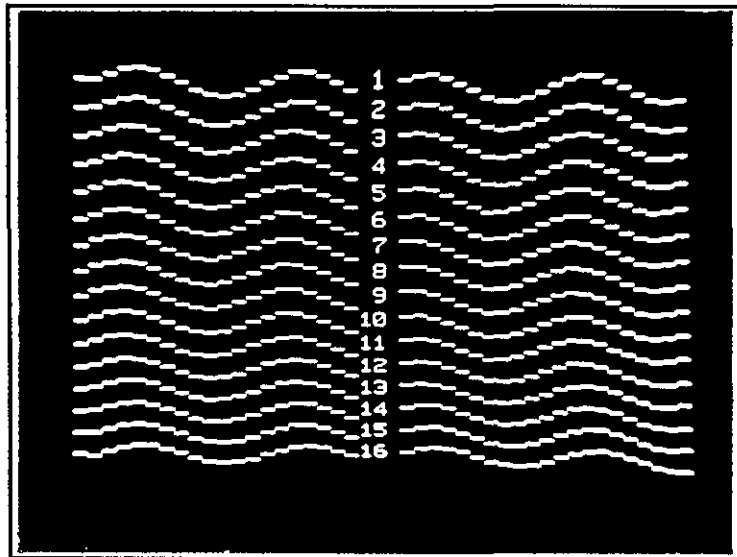

Fig.2.4 / 2.

2 Metre Focussed Data

Data buffer display of contents with a 2 metre focus. This focussing effect reduces the length of the near field and aids plotting of the far field directivity. Useful when working at short ranges in a test tank environment.

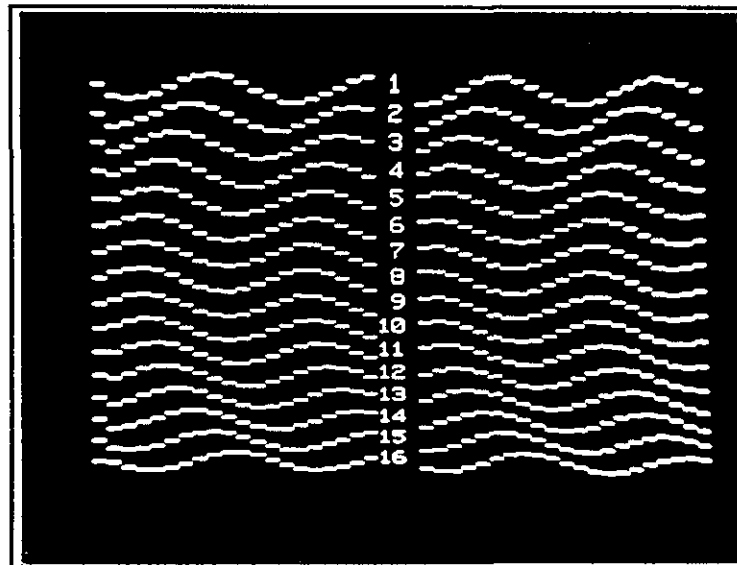
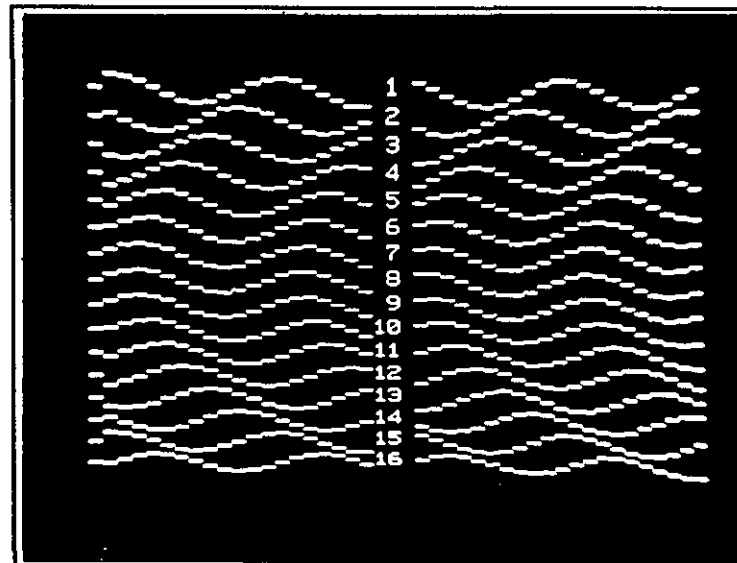

Fig.2.4 / 3.

1 Metre Focussed Data

Data buffer display of contents with data to focus at one metre

Note. This technique can very significantly increase the signal intensity at the focus which can aid investigation of cavitation and non-linear effects.



signals to form a focus at any required range in the near field. The reduction of the near field allows accurate plotting of farfield beam patterns within the confinement of a test tank and, as the intensity at the focus is increased, cavitation and non linear effects can be investigated without overstressing the array transducers. Comparative beam patterns plotted at 2 metres range, i.e. well inside the conventional nearfield, are shown in chapter 6. The phase advances required to focus the array are illustrated by the display of the buffer contents, (fig.2.4/1,2,3).

2.5 Sidelobe Shading.

Techniques for array shading, primarily to achieve reductions in sidelobe amplitude at the expense of the primary beam width, are well established theoretically e.g. Dolph-Chebychev⁴, and have been applied commercially in some radio communication antenna. Acoustic applications of this method, published in the open literature, appear to have been limited to a few specialised examples of fixed beam forming applied in fishery research. Sidelobe suppression even at the expense of beam width ought to prove advantageous in reverberant conditions but the advantages gained may not compensate for the loss of source level incurred. The application of sidelobe reduction techniques to swept beams may prove to be important if bearing coded transmissions are employed for a transmitter scanned sector sonar. In practice the success of Dolph Chebychev shading has proved to be very dependent upon the mechanical phasing of the transducer piston heads i.e. on the manufacturing tolerances maintained during the array assembly.

A channel matching facility has been included in the multimode transmitter which permits fine amplitude adjustment of the synthesised drive signals to compensate for gain variations and transducer efficiency variations in each channel. The amplitude adjustments are made using a plug in passive attenuator card and the matching technique is simplified by the use of EPROM based test signals, (see 2.8). Signals received by a hydrophone in the far field for each channel are adjusted until equal in amplitude. Alternative attenuator cards can be preset for specific power levels or used to apply fixed weightings to the channel signals and these cards can be interchanged as required. The experimental investigation of Dolph-Chebychev shading described in chapter 6 used channel amplitude weightings introduced by this attenuator card.

2.6 High Power Non-linear Operation.

An anticipated requirement of the Mk.2. equipment was a need to achieve very high source levels in the water to facilitate the investigation of non-linear acoustic effects. Transducer power output is limited operationally by the static water pressure and by the area of transducer face coupling the signals into the water. A limit to the maximum pressure differential between positive and negative pressure peaks in the wave form exists at the 'cavitation limit', when the negative signal pressure drops below the static pressure. If attempts are made to drive the array beyond this limit, dissolved gases will start to emerge from solution and a 'rectified diffusion' effect^{5, 6} can take place causing rapid growth in bubble size. In *extremis* the gas bubbles form as 'streamers' on the face of the array and the dispersive effect of the bubbles will destroy much of the acoustic beam forming. Under these conditions a potentially dangerous acoustic mismatch is created at the array face, significantly increasing the mechanical and thermal stress on the transducer. As source levels increase, and as the transducer approaches its cavitation limit, signal distortions will occur. Close to the transducer face the presence of asymmetrical distortion in the signal waveform will indicate the onset of cavitation. For a parametric sonar a second non-linear effect is normally exploited. During the passage of the compression cycle of the signal waveform the density of the water is effectively increased and during the subsequent rarefaction decreases. Since the velocity of sound depends primarily on the density of the medium different parts of the waveform will tend to propagate at different speeds. If the pressure differential is large enough, and sustained for sufficient range, the sinusoidal transmission will degrade towards a saw-tooth shape and, if achieved, will initiate a shock wave at some specific range. At significantly greater ranges the more rapid attenuation of the high frequency components in the waveform starts to return the wave shape towards a sinusoid. This non-linear behaviour encourages the transfer of energy into the harmonics of the signal. Low frequency pressure waves can be derived, either by mixing two coaxially propagating beams of differing frequency which 'beat together' as they propagate in the water or from an amplitude modulated transmitted carrier. The appearance in the water of a 'parametric' beam formed within the original main lobe approximates a virtual 'endfire' array^{7, 8}. This 'endfire' array absorbs energy from the 'pump' primary excitation beam until range attenuation of the originating carrier

reduces the pressure differential below that which generates significant nonlinearities. Whilst the transfer efficiency is quite low⁹, the technique permits wide band low frequency signals to be formed into very narrow beams which are effectively sidelobe free if the full length of the virtual array exists before the measurement point. Additionally the source array can be physically small compared with a comparable primary array for the required low frequency beam width. Some preliminary experiments demonstrating parametric effects are detailed in chapter.6.

2.7 Bearing Coded Transmissions.

Sweeping or Rippling the transmission across a sector still requires a method of establishing the return echo bearing to produce a complete target range/bearing sector identification. Synchronising a sector scanning receiver to the transmission is one solution. Combining both transmitter and receiver scanning provides excellent sector insonification which significantly enhances the useable detection range, largely as a result of the transmitter directivity.

A signal processing technique which only requires a single hydrophone or vertical receive array is a very attractive concept, especially for the reception of low frequency parametric signal echoes. For transmitter scanning alone to identify target bearings the transmission must be encoded. Sophisticated orthogonal codes combinations for transmission have been proposed by Ross¹⁰. However a simple practical set of orthogonal codes can use frequency modulation, provided that adequate bandwidth can be exploited in the transmission to permit separation of the bearing information on receive to be achieved by narrow band filtering. The design of a totally digital receiver utilising a TMS320-10 Digital Signal Processor to perform real time digital filtering has been the subject of parallel LUTEE research work¹¹. A number of alternative bearing coding methods are possible with the increased band widths available from NLA transmissions. e.g. The use of phase reversal techniques or non-ambiguous (pseudo random) sequences of frequency blocks. Quite complex code sequences can be implemented using the Multi-mode Transmitter. However suitable multichannel correlation techniques will need developing before they can be exploited by a practical receiver.

A unusual method of encoding bearing information into the transmission at the carrier frequency, which illustrates the adaptability of the transmitter is shown in fig.s 2.7/1,2,3. This mode is derived from a multiple sweep

Fig.2.7 / 1.

Multiple Sweep Coding.

Echoes display bearing information as a centre pulse position displacement within the triple pulse.

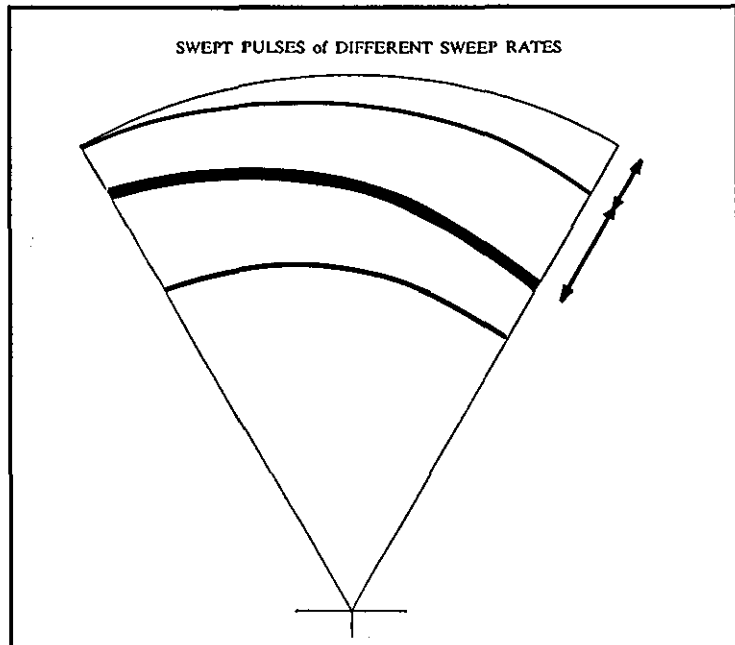

Fig.2.7 / 2.

Multiple Sweep Pattern.

Hydrophone response on the centre axis, 0°.

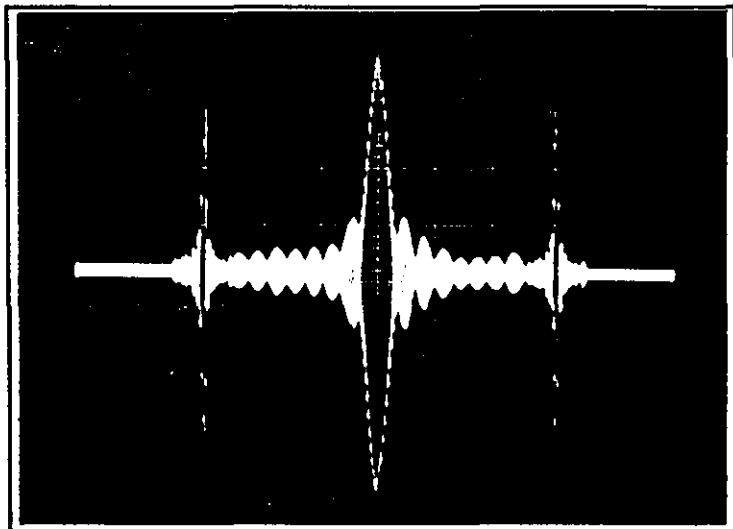
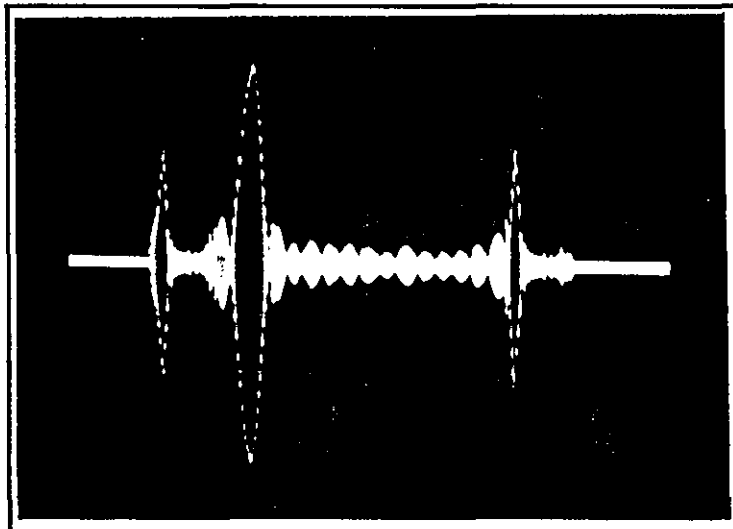

Fig.2.7 / 3

Multiple Sweep Pattern.

Hydrophone deployed off axis at +24°.



signal transmission constructed in this example from three sector sweeps generated contiguously. A combination transmission comprising 1, 5 and 1 millisecc sweeps across the sector are transmitted. Total pulse duration 7 milliseccs during which each potential target has been scanned 3 times. The triple echo response from a target exhibits a temporal displacement of the middle pulse directly related to target bearing. A matching receiver to exploit this has not been attempted. It seems probable that the technique will involve receiver complexity approaching that of a conventional scanning receiver and is unlikely to be competitive.

2.8 Test Signals.

The multi-mode system comprising 16 parallel channels can tolerate the loss of one or more channels without serious performance degradation in some applications. Such 'soft' fail characteristics are desirable but the effects may not be immediately apparent from target echo examination. To align the system correctly and to assist in system fault diagnosis a number of test modes have been developed.

For setting up and matching channel outputs, identical unsteered data is used in each channel drive. Each of the 16 stacked locations in the buffer contains the drive for one channel only. By observing the transmission on a hydrophone as the data buffers are ripplefired, a pulse constructed from the sequential output each of the 16 channels can be examined. For practical purposes the observing conditions remain constant and direct amplitude comparisons can be made, (fig.2.8/1). A missing or mismatched channel is immediately obvious and the appropriate matching adjustment simplified, (fig.2.8/2). By first pre-setting the power level in one channel using a dummy load to create a reference channel, the remainder can all be matched to establish the total power transmitted.

A multi-burst frequency test is constructed by storing different carrier frequencies in each stack location.(fig.2.8/3). All amplifiers contribute and the transmissions beamform on axis. The multiburst mode generates a chirp of discrete frequencies and can be used to measure the complete system response. This mode also has a potential application as a wideband pulse source for examining spectral response of a target. A multi-frequency chirp, used with a matching correlator, could aid the evaluation of pulse compression methods of enhancing signal to noise performance. The possible exploita-

Fig.2.8 / 1

**Test Signal
Channel Alignment.**

Each amplifier channel is transmitted sequentially to permit the relative amplitudes to be compared, within one transmission.

Mismatched or missing channels are immediately detectable.

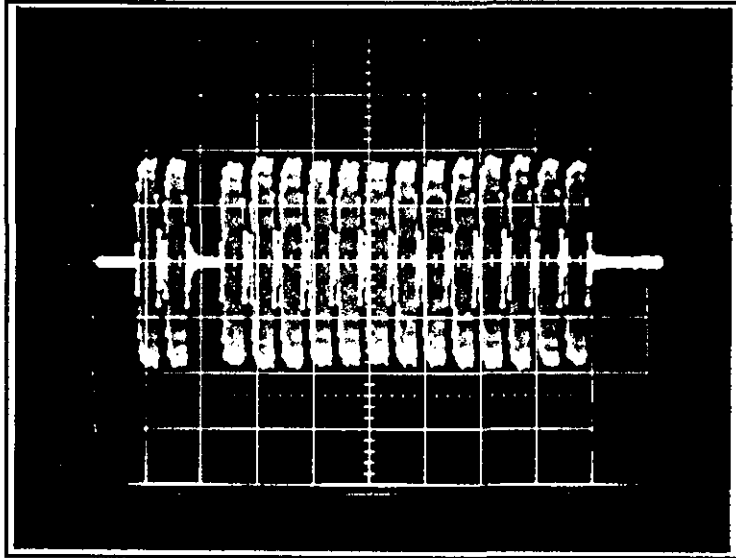

Fig.2.8 / 2.

**Test Signal
Channel Alignment.**

Signal received on the hydrophone after channel adjustments to match the received amplitudes are complete.

The Levels are set to a calibrated power level by first adjusting channel 16 using a dummy load.

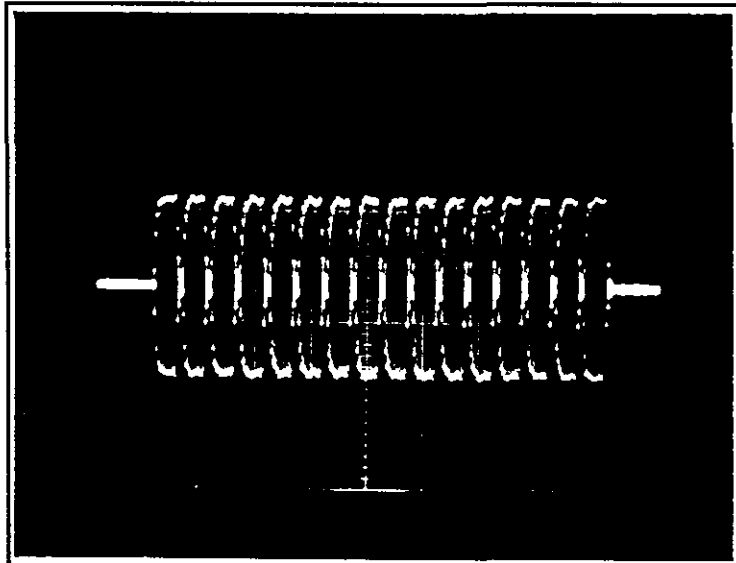
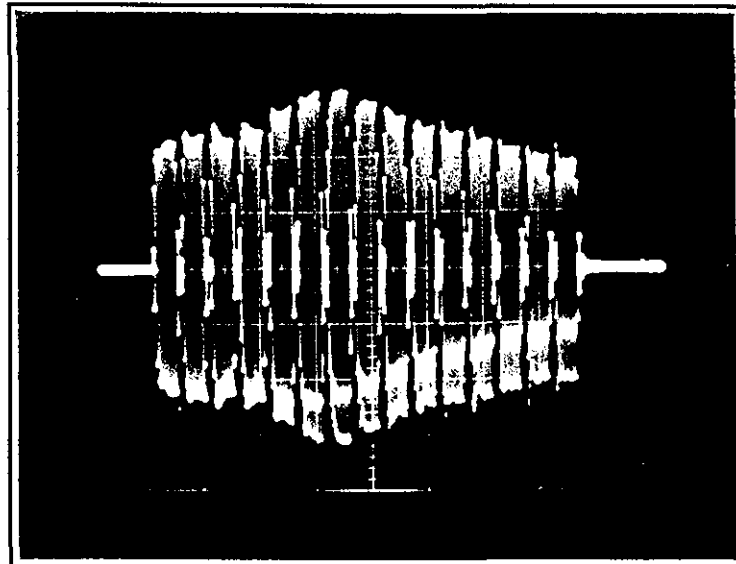

Fig.2.8 / 3.

**Test Signal 36-50 kHz
Frequency Multi-Burst.**

Generated by ripple firing the complete data stack. Each block contains a different frequency.

Note. This photo was taken during a high power test. The onset of cavitation is detectable in the negative part of the waveform.



tion of a sector scanning transmission, bearing coded by frequency, is a concept still to be fully investigated. A possible approach to a receiver design based on the concept of transmitter scanning is discussed in chapter 7.

A MULTI-MODE SONAR TRANSMITTER

Chapter 3 HARDWARE.

3.0 Hardware introduction.

The Multi-mode system comprises:

A microcomputer based signal generator which can simultaneously output 16 analogue channels. The analogue drive signals are fed to a set of linear power amplifiers, 15 x 130 watts in the Mk.1 design and 16 x 1 Kilowatt in Mk.II. These amplified signals drive a multi-channel array via an umbilical cable. The Mk.II array comprises 256, wide band, elements arranged in 16 vertical staves of 16 to permit phase steering in azimuth. The 16 elements in each staff are cabled in sub-groups of 4 elements although only a single drive signal is generated for each complete staff. In the future this array design should permit limited phase steering in the elevation plane, if the additional drive signal circuit complexity can be accepted.

The power to drive the system is normally derived from a 3 phase 50 Hz supply but is 'star' connected to feed the individual units at 240 volts. This arrangement permits development, testing and maintenance of individual sections using a single phase supply, however when driven at full power, the distributed load is less demanding of the trials site feeder cables.

3.1 Micro-Computer.

A Z80 based microcomputer is used to precompute transmission data for a given mode of operation which is first stored on disk or in EPROM. This data is recalled, demultiplexed and stored in, auxiliary paged memory output buffers. These buffer memory pages of 'battery backed' CMOS static RAM are then read simultaneously and the contents translated by 16 simple D/A converters to produce, phase related, analogue output signals. These synthesised analogue signals feed 16 linear power amplifiers to drive the transducer array. The simultaneous output of the signal data is controlled by a programmable logic control card, the parameters of which are set for a given transmission by operator entered instructions to the control program.

Flexible control exists over frequency, pulse length, pause period, pulse sequencing mode, modulation etc.

The transmitter logic was developed around a relatively cheap Z80 based microcomputer¹ which was available for commercial OEM applications from Lucas Logic Ltd. This particular microcomputer, whilst a relatively old design, offers a number of features that are not usually available together in more modern alternatives. The standard facilities on the main board include: Parallel (PIO) and serial (UART) communications, a video display drive and full access to the Control, Address and Data buses. The microprocessor utilises a 4 Megahertz clock. Expansion of the system is simplified by a standard '80 bus'² backplane which is supported by a number of manufacturers. From a construction point of view the '80 Bus' is compatible with the common '5U' 203 mm square development cards which can carry large amounts of circuitry. The standard operating system is well supported with software languages which include a graphics extended BASIC, Z80 Assemblers and a compact implementation of Pascal. The Pascal language had already been exploited in previous projects and found to compile efficient and fast Z80 code which when linked with a 'runtime' package produces 'stand alone' executable 'EXE' or '.COM' type files. CPM 2.2 and CPMplus³ are also available as alternative disk operating systems. The original Lucas/Nascom monitor 'Nas-Sys3' and the associated 'Nas-Dos2.1' disk operating system has been used as the speed of the disk access routines was consistently quicker than when operating under CPM.

An initial study of digital frequency synthesis using a micro-computer demonstrated that in 'realtime' the computation of sinewave samples to generate an analogue carrier would restrict the system to the very low audio frequencies. The enforced low sampling rate definition of the waveform necessitates high 'Q' filtering and this bandwidth restriction reduces the flexibility still further. Speed comparisons were made between sine wave synthesis routines written in the available high level languages. These gave benchmark timings of 0.035, 0.044 and 0.030 seconds per calculated sine sample when using interpreted 8K-BASIC (Microsoft), Extended (Crystal) BASIC and the compiled (BLS) Pascal respectively⁴. The un-impressive improvement when using compiled Pascal is misleading as in this case the computation used double precision arithmetic. A second test utilised precomputed sine values reduced to single byte precision and stored in memory as a

'lookup' table. Using a procedure written in Pascal to simply transfer data from memory to the parallel output port increased the data sample rate to approximately 6 kilosamples/second. Replacing the Pascal procedure with a Z80 assembler routine using the block move commands OTIR or OTDR was more realistic and the output data rate improved to 190 kilosamples/second. A micro-computer based on a Z80A microprocessor running at 4 MHz, with no wait states, can synthesise waveforms at a sampling rate not exceeding 190 kHz using a stored data 'look-up' table. If the synthesised signal is to be used in a tuned narrow band application then the number of samples per waveform cycle can be reduced towards the Nyquist limit and the maximum signal frequency could approach 60 kHz (using 3 samples/cycle). If more than 256 samples are required to be output then additional timing factors enter the output loop and the maximum speed of transfer will be impaired. However, the output data rate achievable from the parallel port is acceptably fast for single channel operation and some early tests of D/A converters, filters and power amplifiers were made at 40 kHz in this way with signals synthesised from approximately 5 samples per cycle. As a machine code module can be incorporated as an 'in-line' or 'code' procedure within a Pascal program or called as an 'external' routine the full speed advantage of the assembled code can be achieved while retaining the flexibility of this high level language.

The single channel 'in-direct' synthesis technique described offers some advantages over earlier hardwired transmitter designs and one hardware circuit design can be easily adjusted to operate over a very wide frequency range by simple software modification. However the economic advantages may not be obvious if the system requires a computer terminal to communicate to the operator. This synthesis approach is less practical when required to generate signals for a multi-channel operation as the necessary multiplexing divides the data transfer rate by the number of channels. Multichannel synthesis using this approach is therefore limited to very low frequencies unless the pre-computed data samples can be accessed in parallel. Dedicating a microprocessor to control the signal generation for each channel under the control of a host processor is one possible solution to this. An alternative approach has been used in this equipment which overcomes the speed problem successfully by extracting the lookup tables from the computer memory and creating an auxiliary RAM memory buffer for each channel. Simultaneous

parallel access to these buffers is made under the control of a hardwired controller which is programmable. The synthesis and transfer of the computed waveform data can now be removed from the transmission loop timing and as a result the speed restriction is imposed entirely by memory speed of access and the associated D/A settling times. With this approach data rates of several Megahertz become possible without requiring exotic components. High data rates may require larger memory buffers as the size is dictated by the length of the transmission and the signal sampling rate required to achieve wideband performance with good phase resolution. If the required multichannel signals differ only in phase then significant savings in memory size can result by recirculating small fixed blocks of memory containing integer numbers of carrier waveform cycles. This compromise using a block length of 256 samples clocked at 500 kHz has been found a very effective technique.

For normal sonar operations the required types of emission are always predetermined and can be calculated in advance. To alter the type of transmission requires the contents the output memory buffers to be replaced by alternative pre-computed datafiles called from disk. As data transfer operations require serial access to each buffer in turn there is time penalty enforced when changing the transmission mode of about 50 seconds when using modern 5.25" 80 track floppy disk drives. The use of a RAM 'disk' has been investigated as this offers the fastest method of changing mode however although this is a practical solution most of the available boards are volatile and require re-loading at power on. Winchester technology would seem to be a preferable solution for faster data access. This has not been implemented as the availability, and cost of the Lucas 'hard disk' options has been a deterrent so far. Double Density 5.25" 80 track floppy disk drives have been used for data storage in this equipment and the inconvenient mode changing delays minimised by creating enlarged data buffers to contain a number of different function data files 'stacked' ready for immediate use. Access to the different functions stored in the stack can be made instantaneously by simply altering the read start address. A further advantage gained from stacking sets of data files is created if the data access is continued throughout the length of the extended stack. In this way a sequence of functions can be transmitted contiguously i.e generating a Ripple fire mode. The final arrangement utilised

8 buffer memory cards based on 32 Kb of static CMOS memory. Two data channels, 4 bit resolution, are multiplexed into each card.

To recover the data a control card, with latched pre-programmed parameters, clocks out the digital buffer contents into individual D/A converters which are mounted as small piggyback pcb's on each buffer memory card. An alternative and larger 64 Kb x 8 bit resolution buffer has been designed and tested in anticipation of modes requiring higher resolution and longer unique pulse structures. For most of the trials work so far, 4 bit data signals have been employed successfully to define waveforms using a sampling rate of 500 kHz.

Note. Circuit diagrams are included in Appendix I.

3.2 MOSFET Power Amplifiers.

Bi-polar power amplifier designs for a multi-channel system were rejected in favour of a power MOSFET approach, primarily as a doubts were felt about achieving closely matched linearity at high power with simple circuits. From past experience it was also realised that sophisticated protection circuitry was required to withstand all the forms of reactive mismatch that can occur under trials conditions.

An examination of the characteristics of the newer complementary power MOSFET devices demonstrated that comparatively simple amplifier designs can offer high power and a wide band frequency response from a low component count circuit. The basic specification for the anticipated sonar applications suggested that the linear power amplifier would be required to perform well at frequencies from a few hundred Hz up to 80 kHz. Several promising (cheap) amplifier 'Hi-Fi' modules based on complementary MOSFET devices were available commercially and the investigation started using a 60 watt module purchased from a local Leicestershire manufacturer,⁵. Configuring a pair of these amplifier circuits in a directly coupled 'pushpull' bridge mode, generated satisfactory power levels in excess of 130 watts at 40kHz,⁶. The high impedance and reactive load presented by the transducer was matched using a toroidal wound output transformer the output impedance of which was designed to appear resistive at the operating frequency. The compact nature of this solution encouraged some modifications to improve the slew rate of these devices and a batch of upgraded 'Hi Slew' units were obtained which were expected to achieve 150 watts at 50kHz without stress.

The units were manufactured as a low cost domestic product and required some re-engineering for this sonar application. Initially the amplifier pairs were found to run excessively hot with a full power but low duty cycle pulse mark-space ratio of 1:10. The thermal stress induced several MOSFET failures despite the presence of a thermal trip installed to sense heat sink temperatures. Investigation of this effect revealed a design limitation in the internal phase splitter. This circuit was found to be slew limiting at higher frequencies, and at 40 kHz the phase split shifted significantly from the essential 180 degrees. A DC component was produced by this tracking failure during high power operation and the phase splitter circuit was modified to eliminate the effect. The units were used successfully for the early trials in this form but other, less serious but significant, thermally related effects remained until a thorough investigation of the complementary power FET devices demonstrated asymmetrical thermal tracking characteristics. A conventionally connected configuration, AC coupled, was immune from the problem and ran quite cool at the desired mark/space power level. However, when the amplifier pairs were configured in a 'bridge' mode, the primary winding of the output transformer permitted significant dc currents to flow as the mismatched FET devices increased in temperature. A modification, using suitable electrolytic capacitors, placed in series with the transformer primary produced an effective cure and full power can now be obtained for long periods without thermal distress. These amplifiers were racked together with the drive computer and this transportable assembly is usually referred to as the Mk.1. Transmitter (fig.3.2/1). The equipment was transported to various reservoir trials sites, and used in this configuration for all the initial low power experiments. The maximum power available from this system, some 2 kilowatts, was able to generate significant non-linearity in the water using the 15 element prototype array and when the transmissions were modulated some parametric products were detectable. The success of this prototype lead to the Mk.2 specification requiring 1 kilowatt channels to produce an engineered 16 kilowatt system to assist in parametric performance investigations.

3.3 High Power Linear Amplifiers.

Alternative MOSFET power amplifier modules with a claimed 1 kilowatt RMS rating were purchased from small North London company,⁷.

Fig.3.2/1 The Mk.1.Transmitter Assembly

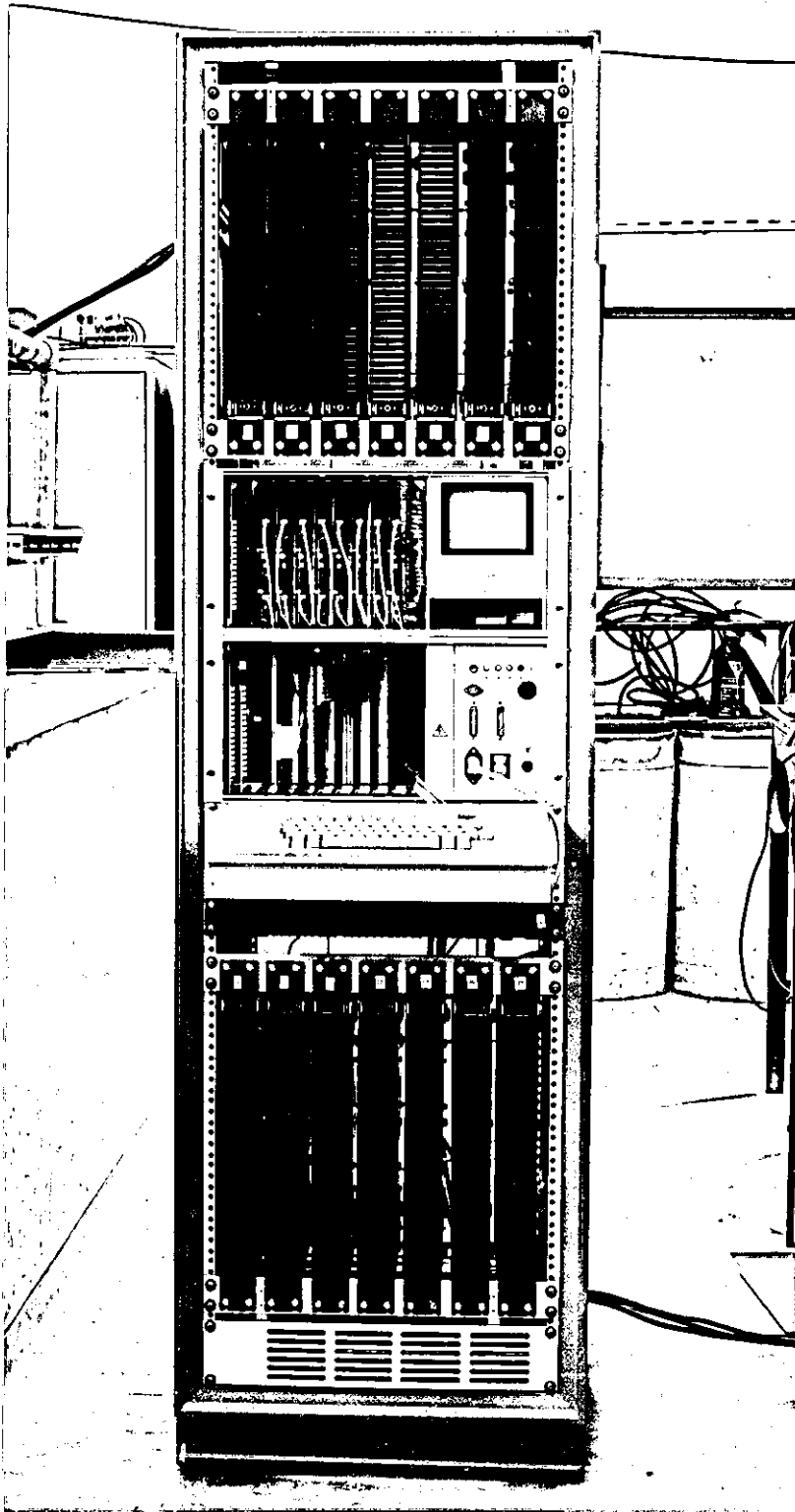

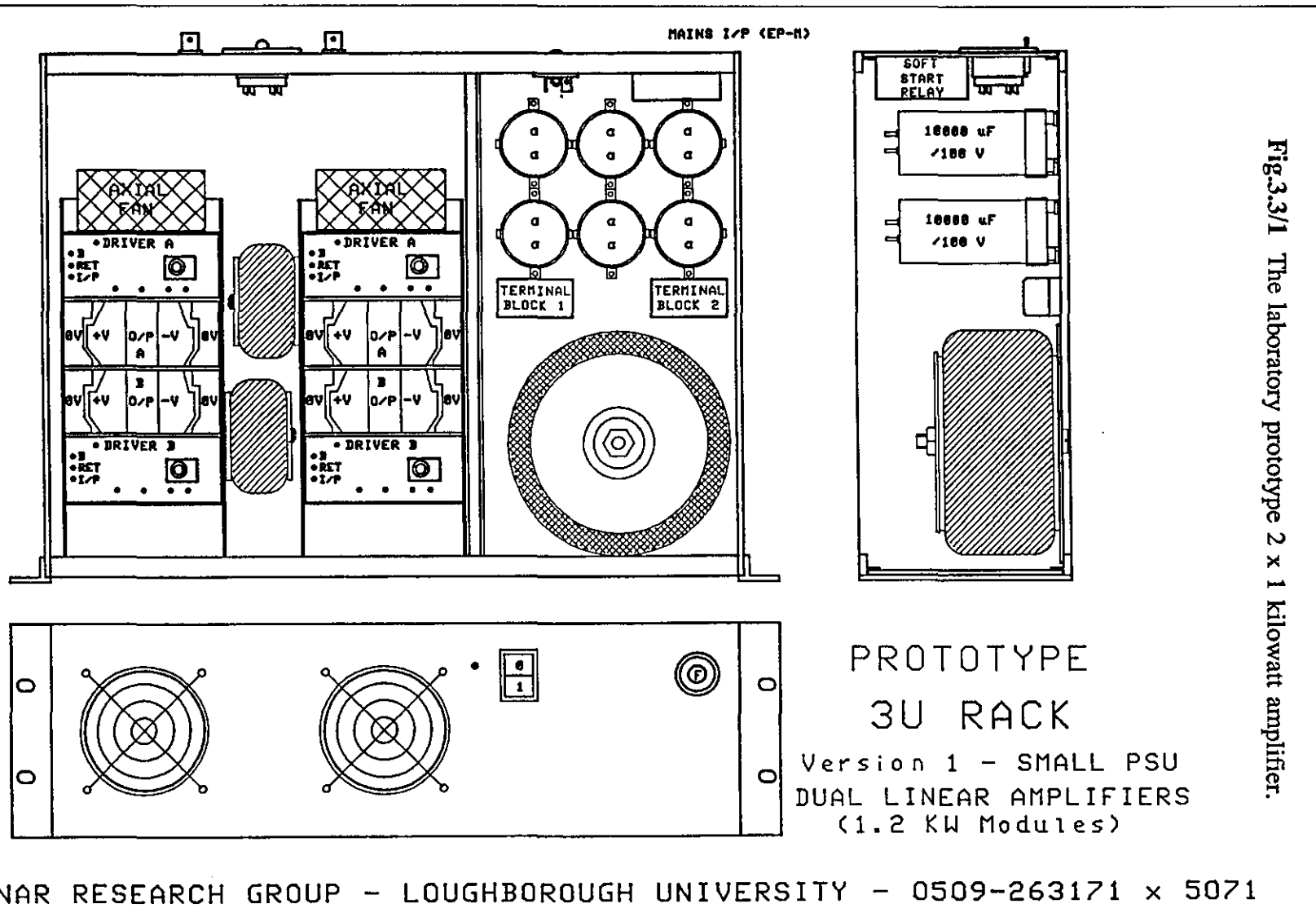

Fig.3.3/1 The laboratory prototype 2 x 1 kilowatt amplifier.

A prototype 2 x 1 kilowatt amplifier with integral power supply was constructed in the laboratory to assess the performance of these modules at sonar frequencies between 10 kHz and 100 kHz, (fig.3.3/1). This unit was a very useful testbed and revealed some deficiencies in the circuitry. Some thermal drift in the quiescent operating point was detected and some high amplitude, very low frequency, instability appeared when the amplifiers were configured to drive an impedance matching transformer as recommended by the manufacturer. When tested with a dummy load the circuit modules were unable to achieve their rated maximum power at 40 kHz. The 1 kilowatt output, available at 20 kHz, fell to less than 800 watts at 40 kHz. Alternative driver circuitry was supplied which just achieved the 1 kilowatt rating for the 100 millisecond maximum pulse length specification, (fig.3.3/2). The low frequency instability noted was eliminated in this experimental amplifier by ac coupling the bridge output connection with a, physically large, 22 microfarad high voltage paper capacitor. Experiments demonstrated that the sustainable one kilowatt output was limited in duration primarily by the reactance of the mains input transformer when required to generate pulses longer than 100 milliseconds. Using a variac to increase the supply rail voltages from +/-70 volts to +/-80 gave a significant power increase,(fig.3.3/3) and an undistorted 1100 watts could be obtained in a matched load for a full 100 millisecond transmission. Alternatively short drive pulses of less than 10 milliseconds increased the available output power to 2 kilowatts or if driven by the maximum pulse length synthesisable (2 seconds) a CW transmission of better than 900 watts could be sustained. The detailed specification was then discussed with the manufacturer who was requested to quote for batch manufacture followed by an order for one unit. A pre-production unit, supplied for evaluation, was returned as problems affecting performance and long term reliability were identified with the driver stage of the circuit. To solve these problems speedily this circuit assembly was removed and redesigned at Loughborough. An improved drive circuit card was then made in the laboratory and when this was installed in the amplifier the unit performed very satisfactorily. The new circuit (Appendix I) and PCB photo-mask was then issued to the manufacturer for incorporation in the construction of the production amplifiers. The performance advantages gained from this re-designed drive circuit included the elimination of a dc feedback loop and the upper frequency response was increased to over 100 kHz. The low frequency coupling capacitors were al-

Fig.3.3/2

The Prototype Amplifier
Maximum O/P

- a) +70v rail sagging
- b) 100 millisecc pulse
measured across 41 ohm
load. - 955 watts.

Note onset of distortion.
The power rails
are sagging under load
which severely limits
the pulse length at full
power.

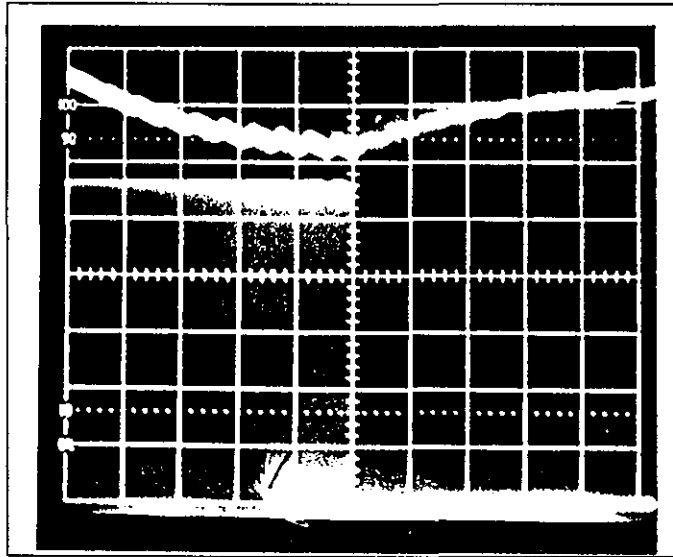

Fig.3.3/3

The Prototype Amplifier
Maximum O/P

- a) +80v supply rail.
- b) 100 millisecc pulse
measured across 35 ohm
load. - 1125 watts.

Note No visible
distortion at the full
rated power/pulse length

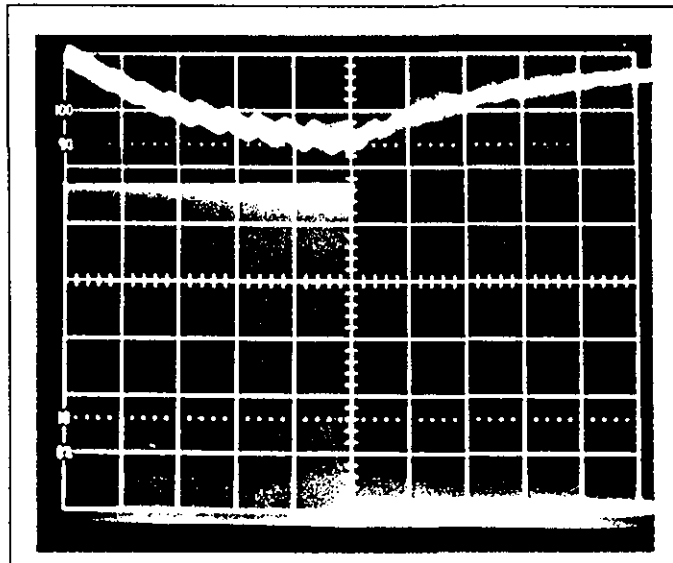
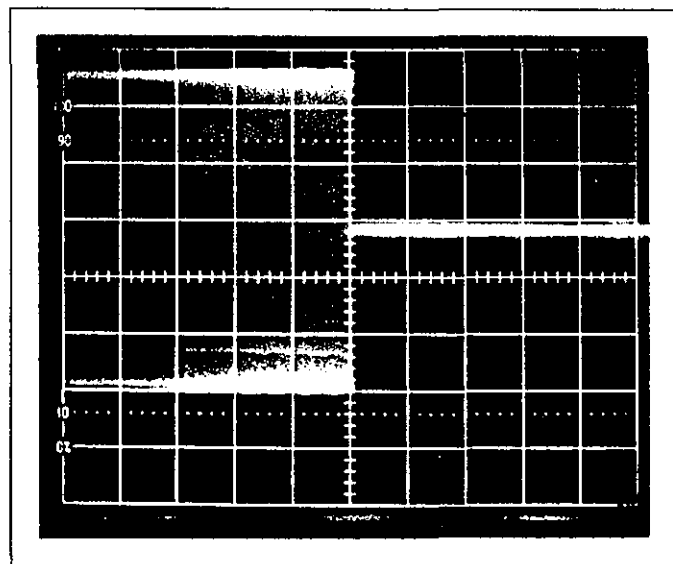

Fig.3.3/4

Final Amplifier for
the Mk.2 System.

- Maximum output power
into reactive dummy load
100 milliseconds 40 kHz
Transmission.
1250 watts into 125 ohm
load.



tered to roll off the low frequency response below 1000 Hz. The new PCB layout reorganised the copper track thickness and pad sizes and incorporated a ground plane. This design permitted a directly coupled transformer output and eliminated the bulky capacitor introduced in the original experimental unit. Eight production versions of these dual amplifier units, 16 kilowatts total, were eventually delivered complete with internal toroidal output matching transformers. These amplifiers were all thoroughly tested on arrival to ensure that they met the design specification. The units were accepted after completing all the specification checks which included a sustained 'soak' test at full power for several hours using a dummy load. The dummy load used simulated the combined loading reactance of the transducer and its cabling. A further problem arose when the transducer manufacturer was unfortunately unable to duplicate the reactive parameters measured in the prototype elements due to variations in his supply of piezo-ceramic. The transducer units finally supplied differed significantly, with much increased capacitance, from the approved samples. Accepting these transducers created a new loading specification for the power amplifiers and the delivered amplifier units all showed evidence of distress when run for long periods with the new reactive load. This design of amplifier prefers to see excess inductance rather than capacitance in a reactive load. The output transformers were redesigned for these new parameters and unfortunately the original cores now proved inadequate. Larger toroidal cores were purchased and the amplifier manufacturer employed to wind a replacement set of transformers. Once these replacements were fitted the amplifier system again exceeded the full power specification of 1 kilowatt / channel for 100 milliseconds when tested using a redesigned dummy load, fig.3.3/4. As the transducer array was supplied as two identical matched half arrays, each amplifier was also required to drive either a half or full transducer stave (8 or 16 elements). This power splitting was achieved using a matched 'bi-filar' dual secondary winding on the transformer. The calculated transformer match for full load proved quite successful when driving the half transducer. Approximately 3/4 power can be coupled into the half transducer load.

3.4 Power Amplifier Performance Summary.

The frequency response of the basic 1 KW amplifier module, tested without an output transformer, extends from 1kHz to 100kHz at the 3dB

points and is essentially flat throughout this range. The output transformer was designed for resonance at 40 kHz at full load to match a transducer element stave and cable capacitance. This assumes that the transformer output is connected to the transducer array using 4 of the coaxial cores (sub-stave connections) in a 40 metre long pair of multi-core cables. These polyurethane jacketed umbilicals, one feeding each half array, each contain 45 miniature coaxial cables, and were manufactured by De-Regt of Holland to an Admiralty specification.

The overall frequency response of the system, including the transducer, was measured in the water and was evaluated using the frequency 'multiburst' test signal mode. These tests indicated a useful 3dB bandwidth extending between 37 kHz and 50 kHz (centred on 42 kHz). The anomalous dip in the response at 39/40kHz is believed to be a characteristic of the transducer array construction, (fig.3.4/1). The eight dual power amplifier

Fig.3.4/1 Frequency response of the complete Mk.2 high power system including the power amplifiers and transducer.

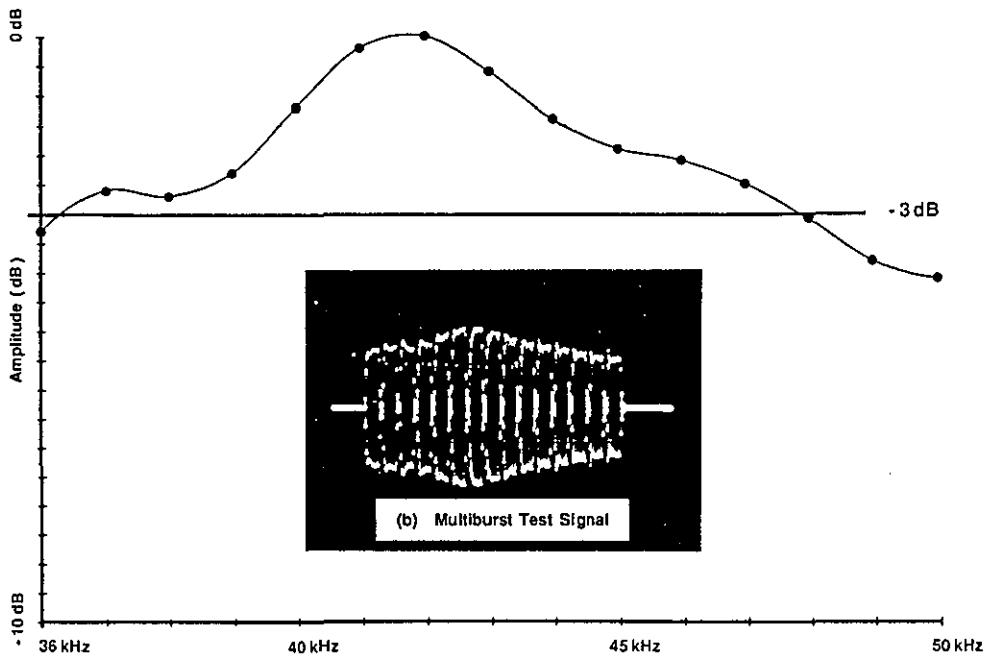

units were racked together, (fig.3.4/2) and wired initially for the 240 volt single phase supply at Foremark reservoir. The mains supply was taken via a 32 amp circuit distribution breaker and a 30 milliamp earth leakage RCCB. The current rating of the breaker was close to the calculated maximum load and the system tripped safely if the programmed output significantly exceeded the 1:10 mark/space specification at full power. For later trials on

board 'Maytime' the system was reconfigured to use a three phase star supply, cable fed from the shore. The on board power distribution incorporated 10 amp/phase circuit breakers. When transmitting at full power and using long pulses the cable impedance of the three phase supply causes a significant dip in the mains supply voltage.

Fig.3.4/2 The complete Mk.2. Transmitter Assembly.

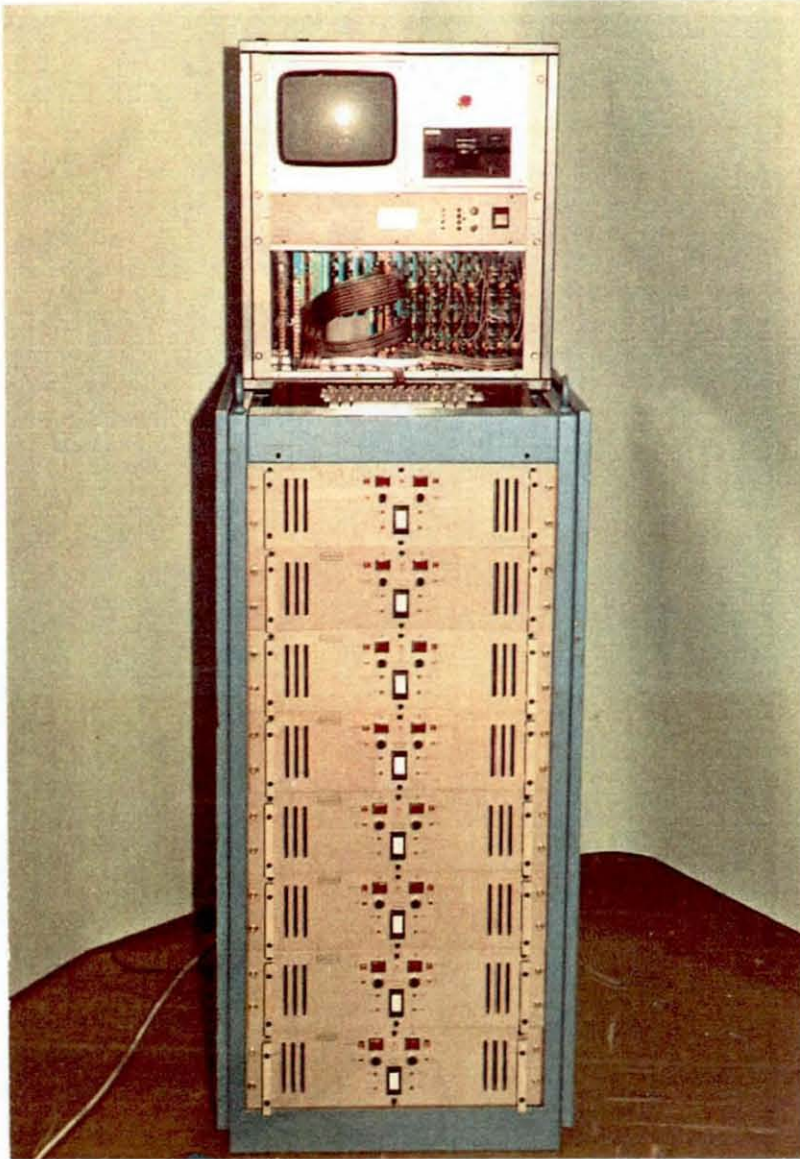

3.5 Transducers and Arrays.

The conventional sandwich transducer construction is based on a stack of PZT4 piezo-ceramic disks prestressed between a piston head and tail mass, a construction usually referred to as a 'Tonpiltz' design,⁸. For commercial and military power transducer applications in the range between 1 kHz and 50 kHz, this design is the most commonly used device. Such elements are also used in matched receiver arrays but alternative, cheaper, hydrophone constructions are also possible when the high power transmission characteristic is not required. The arrays designed for this project utilised sandwich elements with centre frequencies near 40 kHz.

The initial experiments utilised an array made of 39 kHz Hi'Q' transducers. These were standard echosounder elements with a 'Q' of about 7 and a piston diameter of 38 millimeters. The array consisted of 15 of these devices pitched 40 millimeters apart ie approximately lambda in seawater for 40 kHz. The admittance circle plots measured from these demonstrated that they were not ideally matched. Comparing the diameters of the admittance circles demonstrated a spread of 30%, but only two elements were particularly badly matched and they were fortunately not positioned near the array centre. The construction of this array followed a proven LUTEE technique. The transducer elements 'pocketed' in a rigid Urethane foam pressure release material within a nylatron outer case. The front face was sealed after assembly with an Adiprene window. (fig.3.5/1) The electrical connections were passed through an internal bulkhead in the nylatron case to a tag strip junction with the cables. This terminal block was sealed with a back plate and a flexible conduit moulded to it to protect the wiring from damage in the field.

Fig.3.5/1 Array Transducer construction detail.

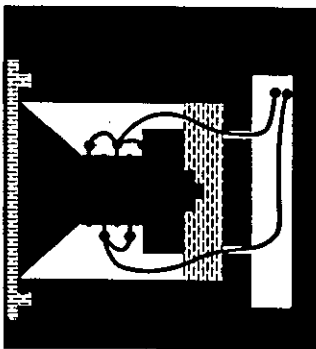
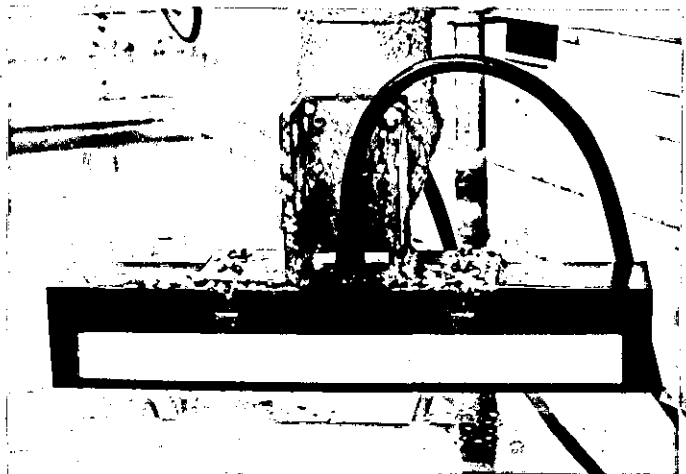

Fig.3.5/2 15 element Mk.1.Array.



The nylatron case in addition had two 'T' slots milled on one side to assist in mounting the array to an underwater training gear, (fig.3.5/2).

Early trials with this array were encouraging. The 'test' mode signals enable the direct comparison of the individual transmitted channel amplitudes received on a test hydrophone. If the receiving hydrophone is deployed on axis and in the far field of the array then, after trimming the transmitted gains for equal received amplitudes, the resulting combined signal beam pattern forms a good match to the computed simulation. This amplitude matching cannot compensate for the significant phasing errors that were inherent in this array's manufacture. But the beam patterns, especially in view of the known poor transducer matching,⁹, are quite acceptable. These high 'Q' elements were found to have an inadequate bandwidth for the very rapid 'swept' signal modes. The element performance was not found to be a limiting factor for the phase (delay) steered transmissions and 'steered' and 'rippled' modes were successfully demonstrated, as were slower rate (5 millisecond) 'sweeps'. During the first trials at Staines reservoir this array was used to demonstrate that basic phased array concepts were practical and that steering and sweeping of the directivity lobe through the 60 degree sector was possible. During later trials with the array driven with the maximum available power, it was established that significant waveform non-linearities could be produced in signal propagating in the water. Cable lengths and mounting limitations precluded deep deployment of this array but at 7 metres depth at Foremark and at full power (2 kilowatts) low frequency echoes could be clearly heard, reflected from the shoreline at 600 metres range, using a square wave modulated carrier transmission.

3.6 Wide Band Transducer Elements.

The Mk.2 system was required to generate much higher powers for parametric signal experiments. An investigation into suitable Low 'Q' elements was undertaken with samples provided by the Institute for Oceanographic Sciences and by Universal Sonar Ltd. The sample element from I.O.S. was constructed from titanium with the piston head precisely trepanned from the solid mounting block, leaving it supported by a thin diaphragm (fig.3.6/1). The PZT4 ceramic rings and the tail mass are assembled to the piston using a rolled thread, titanium tie bar. The element is carefully preloaded by measuring the extension of the tiebar as the assembly

is tightened. The resulting element performs extremely well, the admittance plot of the sample yielding a very smooth low 'Q' circle. However I.O.S. advice suggested that to achieve the maximum bandwidth performance necessitated by our application the design should be restricted to a $1/2$ lambda diameter piston. It was also noted that the compliant diaphragm support technique absorbed a significant proportion of the inter-element spacing. The initial estimated cost of a 256 element array based on this technology was competitive. However the need to achieve a large transducer surface area to efficiently couple the maximum possible acoustic power for parametric experiments implied a need for much greater numbers of $1/2$ lambda size elements and the economic choice was forced towards a Universal Sonar one lambda design.

Fig.3.6/1 I.O.S. Transducer - Titanium element construction.

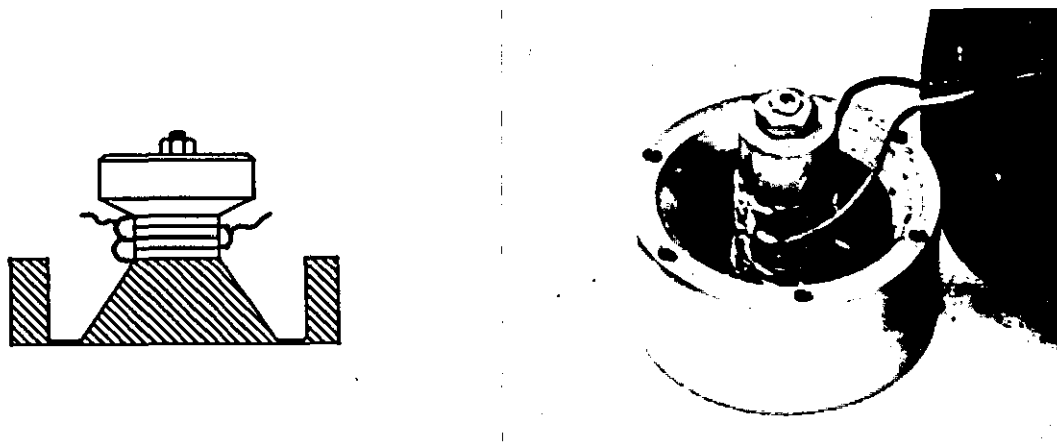

The first samples provided by Universal Sonar proved unsuitable as the specified low 'Q' response was apparently achieved by merging two or more close spaced resonances. This technique produces circle plots which display several deep re-entrant dips in the admittance plot, indicating points of rapid phase shift between the resonances. During the 'sweep' modes of operation such phase changes are unacceptable as they create undesirable distortions in the beam pattern. In the 'sweep' sector modes the individual transducer staves all transmit different frequencies. A second disadvantage of this element design, proved to be a 'self destruct' mode at high power, caused by the very poor thermal conductivity through the piston face. The piston head of this transducer included a glass/epoxy component which delaminated with the heat dissipated during a very short high power test made during the examination of cavitation characteristics. A later example

from Universal Sonar was manufactured with an aluminium piston, with a 0.95λ face, and this demonstrated a single smooth admittance circle indicating a 'Q' of about 4. After extensive tests¹⁰, this was the transducer design chosen for use in the 256 element phased array, (fig.3.6/2).

Fig.3.6/2 Universal Sonar Ltd. - Mk.2. Wideband Transducer .

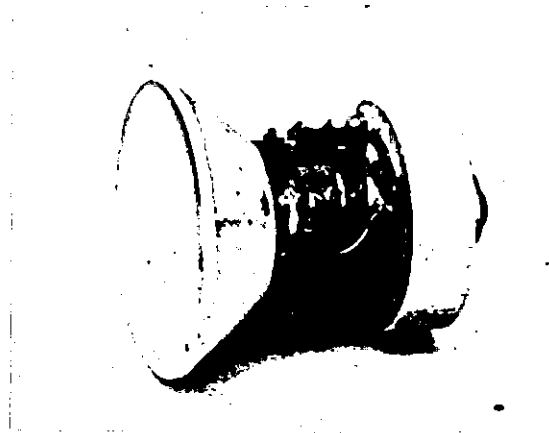
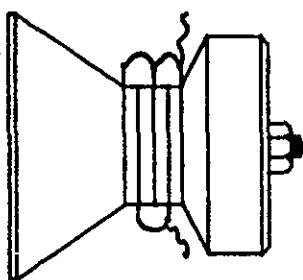

3.7 High Power 256 Element Array.

As the design of a 16 stave x 16 element array based on these elements proceeded it became apparent that the total mass of the assembly was likely to make the array difficult to deploy without specialised lifting facilities. The element design had produced devices with 0.95λ (40kHz) diameter pistons and a matrix of these at λ pitch was envisaged. The side effect of diffraction secondaries was accepted in order to achieve a 4 degree beam. The 'endfire' propagation from a λ pitch array was also an accepted disadvantage. However in modelling the possible effects of a split (dual 128 element) array it was noted that the introduction of a deliberate discontinuity of half λ at the array junction could be beneficial, in that the endfire component in the vertical, unscanned plane, could be nulled significantly¹¹. A final proposal for two identical 128 element arrays was therefore pursued with an assembled aperture of 16λ horizontally (Steerable) and 16.5λ vertically, (Appendix VI). A half array was commissioned first and thoroughly tested before the remaining half was assembled. The expected handling advantages of this split design have been realised. This dual array can be split and either half used alone, at lower power, should the need arise. (fig.3.7/1).

Fig.3.7/1 The Mk.2. Dual Array being deployed at Foremark Reservoir.
Each half comprises 16 staves of 8 elements, i.e 16 x 16 in total.

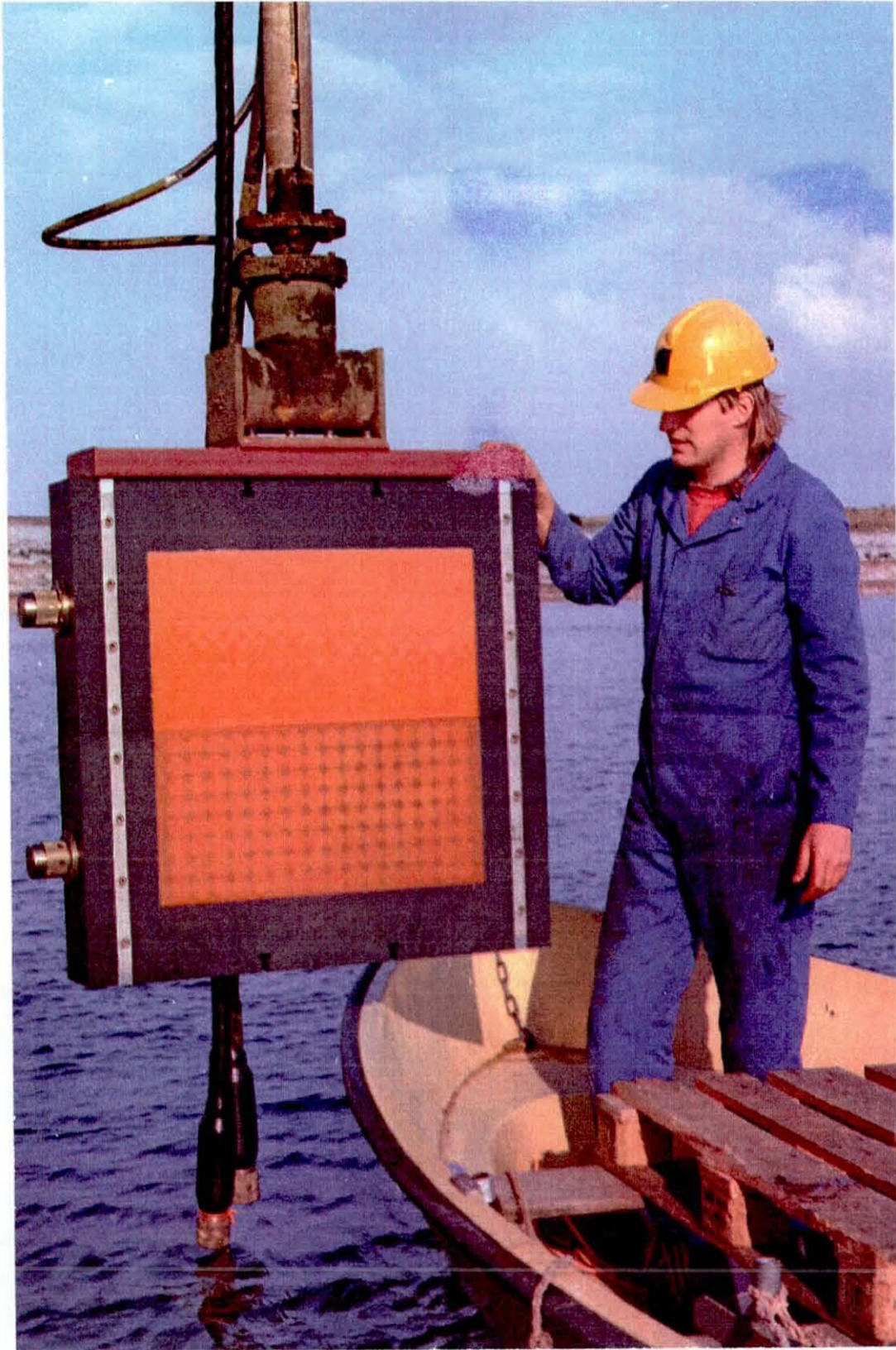

Fig.3.8/1

36-50 kHz

Multiburst Test Signal.

Full array.

42 kHz=1.7 volts pk/pk.

Scales

0.5 volts/div

1 millisec/div.

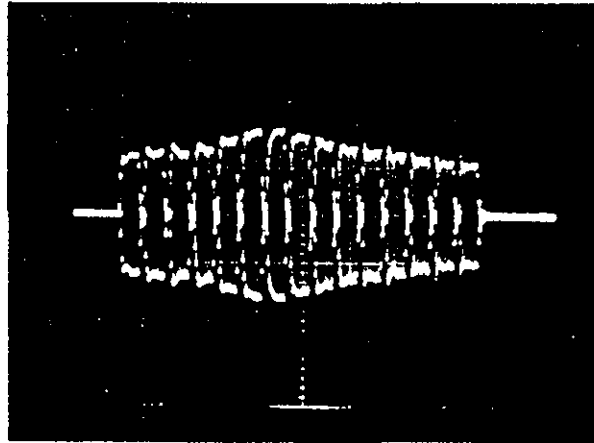

Fig.3.8/2

Multiburst Test Signal.

First half array.

0.2 volts/div.

42 kHz=0.94 volts pk/pk.

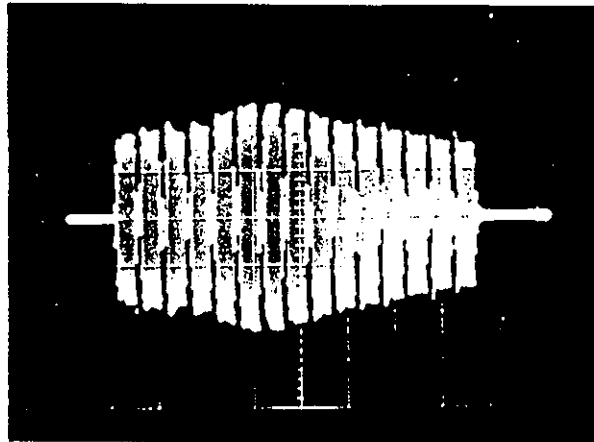

Fig.3.8/3

Multiburst Test Signal.

Second half array.

0.2 volts/div.

42 kHz=0.78 volts pk/pk.

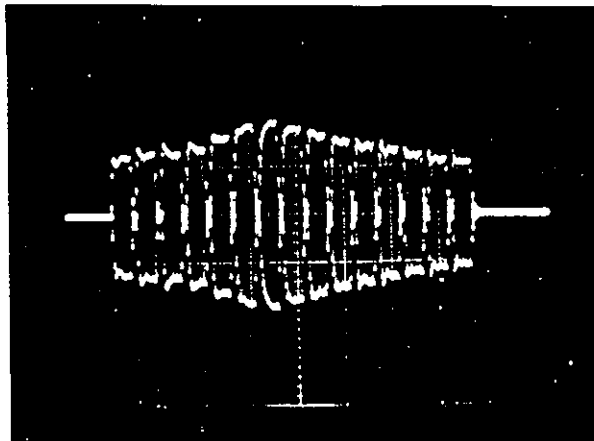

Fig.3.8/4

Freshwater
Beam Plot at 42 kHz.
Full array.

Linear Plot
Beam Width= 3.4°

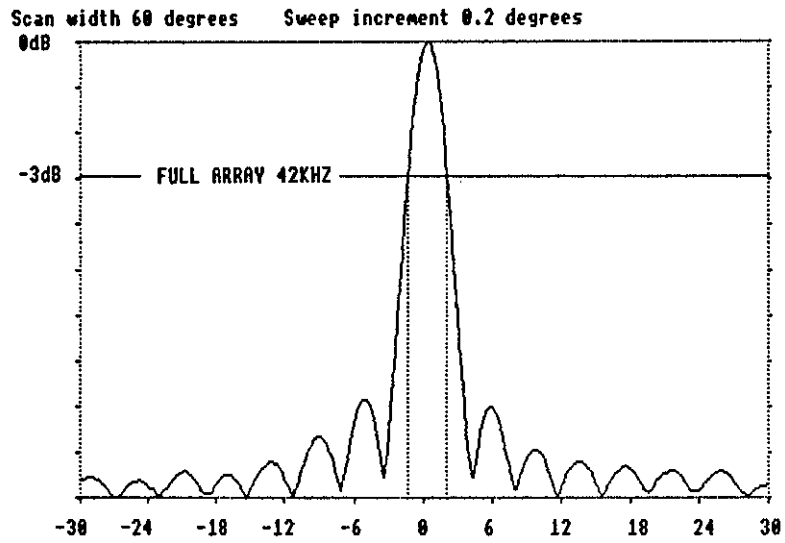

Fig.3.8/5

Freshwater
Beam Plot at 42 kHz.
First half array.

Linear Plot
Beam Width= 3.4° .

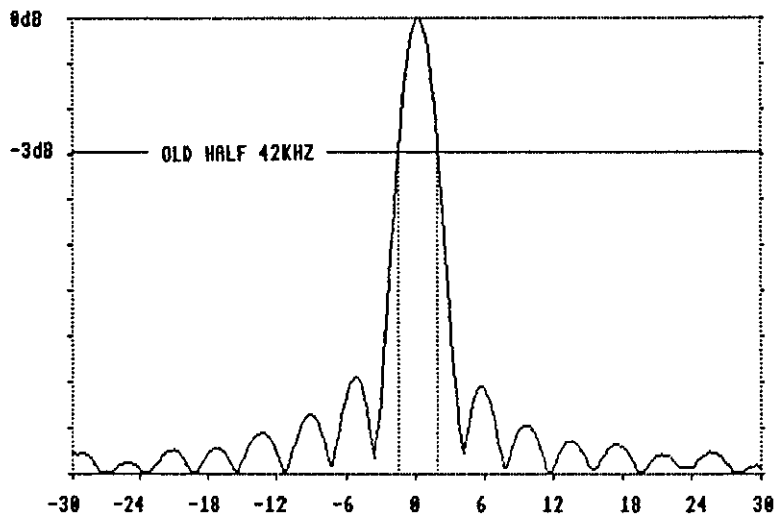

Fig.3.8/6

Freshwater
Beam Plot at 42 kHz.
Second half array.

Linear plot
Beam Width= 3.5° .

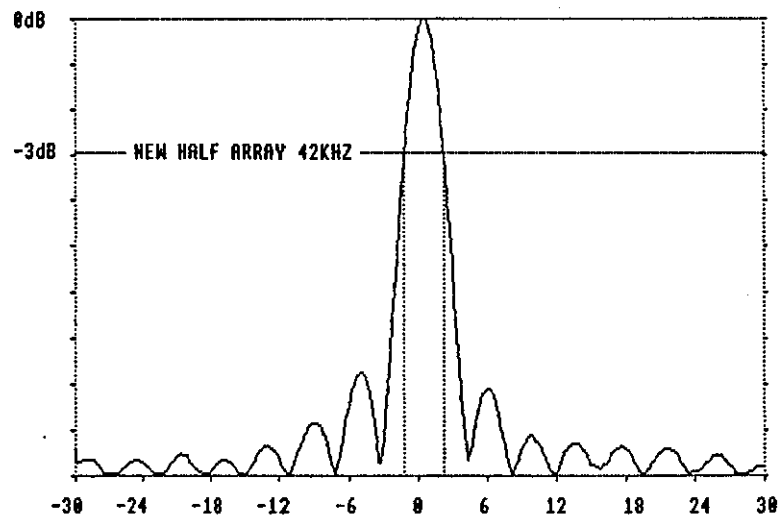
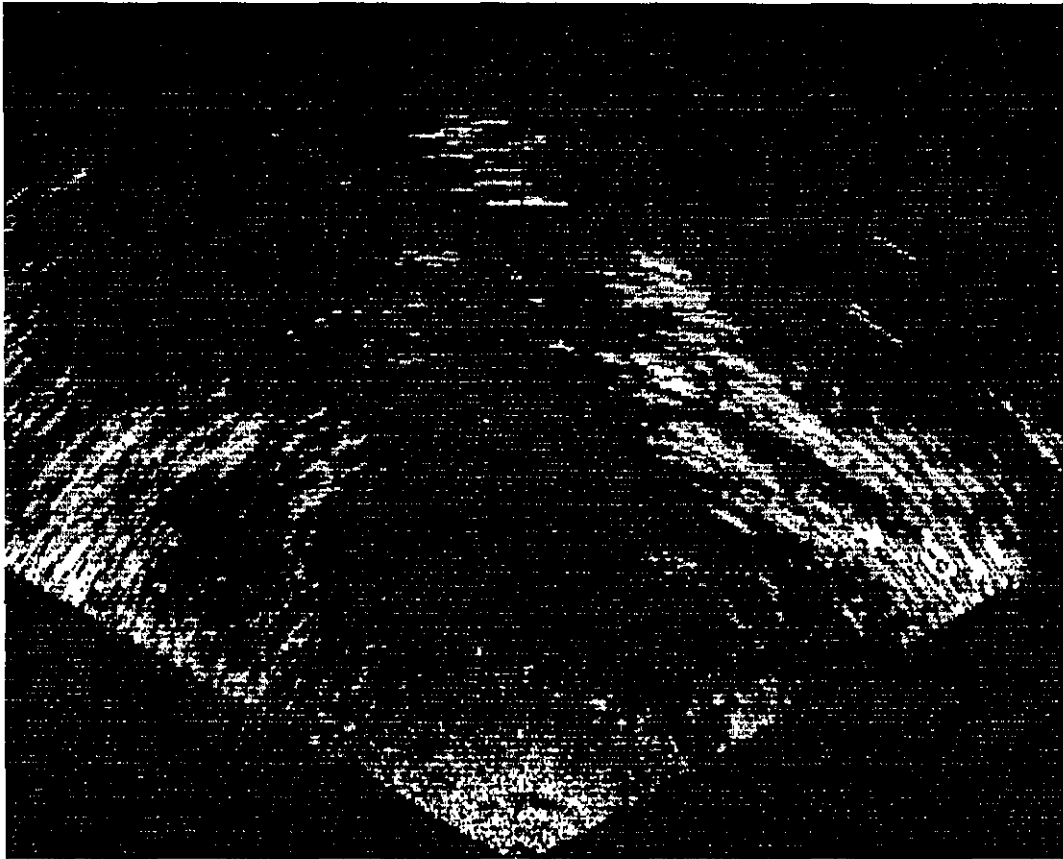

Fig.3.8/7 Foremark Reservoir Lake Bed. - 400 metre sector, 120 degree mechanical scan at 43 kHz, Array tilted down 6 degrees.



3.8 Array Testing.

A variety of modes have been tested successfully using the new array. The array stave matching was measured in the water using the 'multiburst' test signals (fig.3.8/1,2,3) and the plotted beams formed by each half array and by the combined full array are well matched and very close to the simulated patterns, (fig.3.8/4,5,6).

Moving the underwater training gear in small angular steps under computer control, permitted mechanical sonar scans of the reservoir to be produced. Using 43 kHz transmissions a sequence of images which include lake bed detail of the original valley floor, (fig.3.8/7,8) and the shore line out to 700 metres range have been plotted and displayed. These results were obtained using the 16th stave of the array as a matching hydrophone to feed a single channel 'Hybrid' receiver,¹².(Compare with fig.5.3/3)

The full size array was deployed at a depth of 13 metres in Foremark reservoir. The array was driven with 10.5 kilowatts, which was determined to

Fig. 3.8/8. Foremark Reservoir Lake Bed. - 800 metre sector, 120 degree mechanical scan, Array tilt is zero.

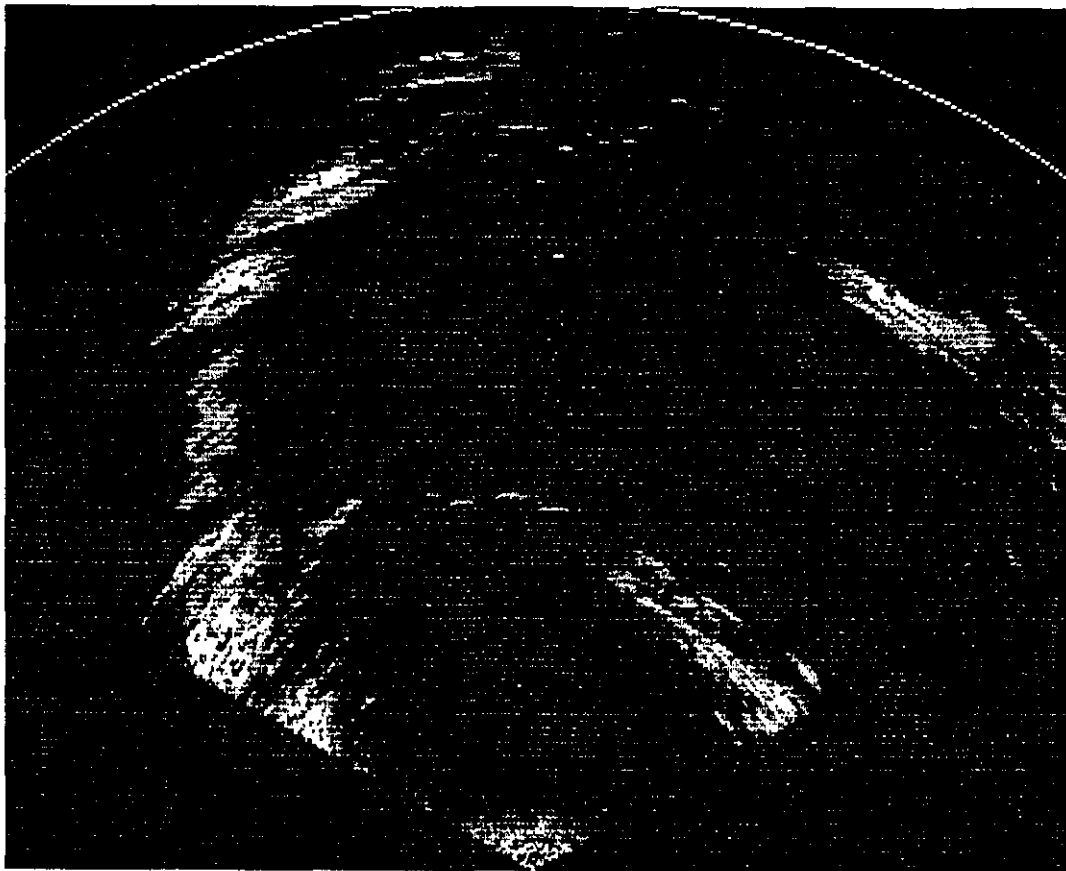

be the maximum power that could be coupled into the water without cavitation at this depth. Very significant waveform non-linearity was visible on the test hydrophone deployed at 9 metres range and, when using square wave modulated transmissions, very strong low frequency echoes from the far shore line were clearly audible. Finally when redeployed at Lochgoil in Scotland the 256 element array was deployed at 33 metres depth, limited by the maximum cable length. The full 16 Kilowatts power has been employed and is coupled effectively to the water with the increased static pressure. The initial Lochgoil experiments re-measured all the parameters established in the Foremark reservoir lower power fresh water trials. These first trials in deep water in a less confined range environment demonstrated that the source level and array beam forming performance in seawater at full power were close to the predictions made from the earlier freshwater, limited power tests, provided the effects of sound velocity on the array directivity, and increased absorption were included.

3.9 Mk.II. Array Parameters - Summary

Sea Water Measurements made at Lochgoil.:

The array centre frequency was 42 kHz.

-3 dB points were measured at 36.5 kHz and 48 kHz,
i.e. the array bandwidth was 11.5 kHz, a 'Q' of 3.6.

The array beamwidth, at 42 kHz, unsteered azimuth, was 4.1 degrees.

The array beam pattern could be accurately phase steered
through +/- 30 degrees. (The equal amplitude ambiguity point.)

The Directivity Index is 34 dB.

The RMS source level at 41 kHz was at 245 dB

(reference 1 microPascal at 1 metre)

measured with 16 Kilowatts power input to the array.

A MULTI-MODE SONAR TRANSMITTER

Chapter 4 SOFTWARE

4.0 Software Introduction.

The microcomputer chosen has a large library of commercial and public domain software packages, most of which are targeted on the CPM disk operating system environment. The deliberate choice of the rather basic Lucas 'NasDos2.1' environment was made primarily for its fast floppy disk file handling capability. This speed advantage is gained as direct result of simple disk file handling primitives which do not try to emulate a virtual machine for transportability, as occurs under CPM. However, although the support software available is more restricted in this environment, several good language implementations and Z80 assemblers are available. The majority of the software for this project has been written in Pascal.

4.1 Languages - Z80 Assembler / BASIC / Pascal

A number of small machine code routines were written in Z80 assembler during the early development phase of the projects. Some of these programs were test routines used to obtain timing comparisons and most of these have been superceded. A few small Z80 code segments have been retained and are called as 'external' routines from the Pascal control programs. These pre-assembled code segments can be conveniently trapped in the program text file as 'code modules' ready for insertion during compilation using the Pascal 'External' and 'Code' function calls.

A graphics extended version of Interpreted BASIC was used to compute some of the some of the array simulations. The BBC microcomputer proving a useful tool where a graphic display of output was required. BBC BASIC, and routines written in the BBC inline 6502 Assembler, were employed to control the pan and tilt beam plotting hardware. As the plotter program evolved its size outgrew the limited memory of the machine and necessitated breaking it into several smaller programs which are 'chained' as required from a menu. The Extended Crystal BASIC available on the Nascom II offers similar graphics advantages but as with all interpreted languages the program size in memory becomes a problem with very large

programs. Speed of computation became a secondary consideration after the design approach changed from on line synthesis to pre-computed data. Achieving the maximum speed of data transfer from the floppy disk was regarded as important as the data file transfer time creates a significant delay when changing between modes. Both Interpreted BASIC and the Z-80 Assembler language were seen to be restrictive in this application. The available Pascal language subset was preferred for the system control and data preparation programs.

The version of Pascal selected as the high level language for this project is a derivative of Standard Pascal written by ApS of Copenhagen specifically for the Lucas Nascom microcomputer. This compact version of Pascal, whilst omitting some features of the ISO standard ¹, is well suited to programs designed to run on the compiling machine.

BLS Pascal v 2, consists of a 12 k development package comprising Compiler/Editor/Runtime routines extended by a further 4 k set of disk operating routines, Pascdos ². The advantages of this version includes one pass compilation direct to Z80 object code which, when linked to a small runtime package, produces fast stand alone code that is quite compact. The structured modular nature of the language suits the development of large programs, especially where continuous program development and updating is required. The self documenting nature of the language is also seen as an advantage.

Turbo Pascal ³ is a more recent version of the Pascal language with similar advantages to the BLS Pascal. This is available to run on Z80 based microprocessors under the CPM operating system. However the use of the CPM operating system imposed some speed disadvantages when compared with the BLS/Nascom implementation and, whilst Turbo Pascal remains a more transportable version of the language with useful additional extensions to Standard Pascal, the original BLS version was retained for this project. It was established that text file transfer was possible between the BLS and Turbo versions and that only minor modifications to the syntax was necessary for successful recompilation. As Turbo Pascal is now available running under MS-DOS it becomes a better choice if the system is to be transported in the future to run for example on an IBM PC.

4.2 System Software.

The system software evolved into two basic suites of programs. The first group is a dedicated set of data file preparation programs. This generates sets of data files onto disk as required for each specific signal mode. The second group consists of operational programs which first call and load appropriate data files and then offer the operator a choice of parameter options to generate specific sonar emissions.

A large number of programs were written as the project evolved, many of which are quite similar, varying only in the accessibility to particular functions. One difficulty experienced, which requires further refinement, is the level of 'user friendliness' that is required by an unskilled operator of the system. The early software retained a greater level of flexibility but required care to be exercised by the operator as error trapping to avoid illegal transmission parameters was incomplete. The program example 'STEERd', examined in 4.3, does not eliminate all the conceivable entry errors when setting parameters. However as installed the Mk.2 transmitter hardware is tolerant of this form of abuse, and the system as a whole is designed to be robust to the point of surviving a programmed gross overload, even one which can trip the supply breakers.

In pursuit of simple operator interaction some sacrifice in flexibility has resulted in the issued versions of the software. The concept pursued in the later versions of the control software resulted in a set of dedicated disks each designed to carry out specific sonar operations. Separate control disks are now used to select operations under the headings:

- 'Test Signals',
- 'Frequency Chirps',
- 'Within Pulse Sweep Signals',
- 'Focus Steer',

'Steer/Ripple/Ping Sector'. The program STEERd incorporates most of the features typifying a control program. This software is analysed in more detail in this chapter and its listing is included in Appendix III.

The data preparation programs have evolved as a family of similar structures and the program RIPPLE60 is included as an example of these.

Several supporting programs, also written in Pascal, relate to the modification of the prepared sets of file data, e.g. to add amplitude modulation for NLA experiments. A utility program DISPLAYf was also written to

extract the first and last few samples from each of the 16 parallel data channels in each file and display them graphically for comparison, as exemplified in chapter 2. A variety of such software tools were written as required while developing and debugging the data files as were programs to model and graph plot the predicted array beam patterns.

4.3 Program Example - Data Synthesis.

RIPPLE60

This program generates the data required to synthesise sonar signals at a specified carrier frequency and prepares a set of 16 data blocks each defining a phase steered increment across the sector. The program source text can be modified easily before compilation if a narrower sector is required to be scanned.

The stacked set of data for all 16 bearings are stored with constructed filenames onto a floppy disk. Each file contains the data for one 256 byte block in all 8 RAM card buffers. i.e. the data required to steer a transmission onto a single bearing. The third character in the filename encodes the position of the block within the stack. In the transmitter the set of files are called for, in turn, by a matching control program (STEERd), and the filename ensures that the data is automatically loaded at the correct stack address on each output buffer memory card.

The data is computed as 4 bit resolution 500 kHz sampled data to fill a 256 byte sample buffer. Channel paired 4 bit signals are multiplexed as an 8 bit buffer block for efficient file storage and speed of data transfer. This program prepares data off-line quite slowly, and although its operation could be speeded by the use of a 'look up' sine table this was not found to be necessary. The program requires no operator intervention once started and will generate a complete data set on the floppy disk automatically.

Flow Diagram RIPPLE60 - Source Text listed in Appendix III.

Notes on the operation of RIPPLE60

Enter the number of cycles of carrier to be stored in a 256 sample 'block'.

Note. A non-integer number required to produce a specific frequency implies that the block length must be abbreviated from the basic 256 samples to ensure that an integer number of cycles fit precisely to permit the data to be re-circulated.

The program outputs the resulting carrier frequency in kHz to the screen before continuing with data calculation.

The data is generated as odd/even channel pairs, and the program multiplexes these two 4 bit data streams into a single 8 bit file which it saves to disc as a 'block'. The 8 multiplexed blocks stored on the disk are file named automatically. The loading address for transmission is encoded within the file name by the 3rd character. i.e. mc8str9 is a data file focussed at 9 metres to be loaded into the 8th position in the transmission stack. (This middle position would normally be loaded with the zero phase shifted data to transmit on the centre axis.)

Flow diagram RIPPLE60

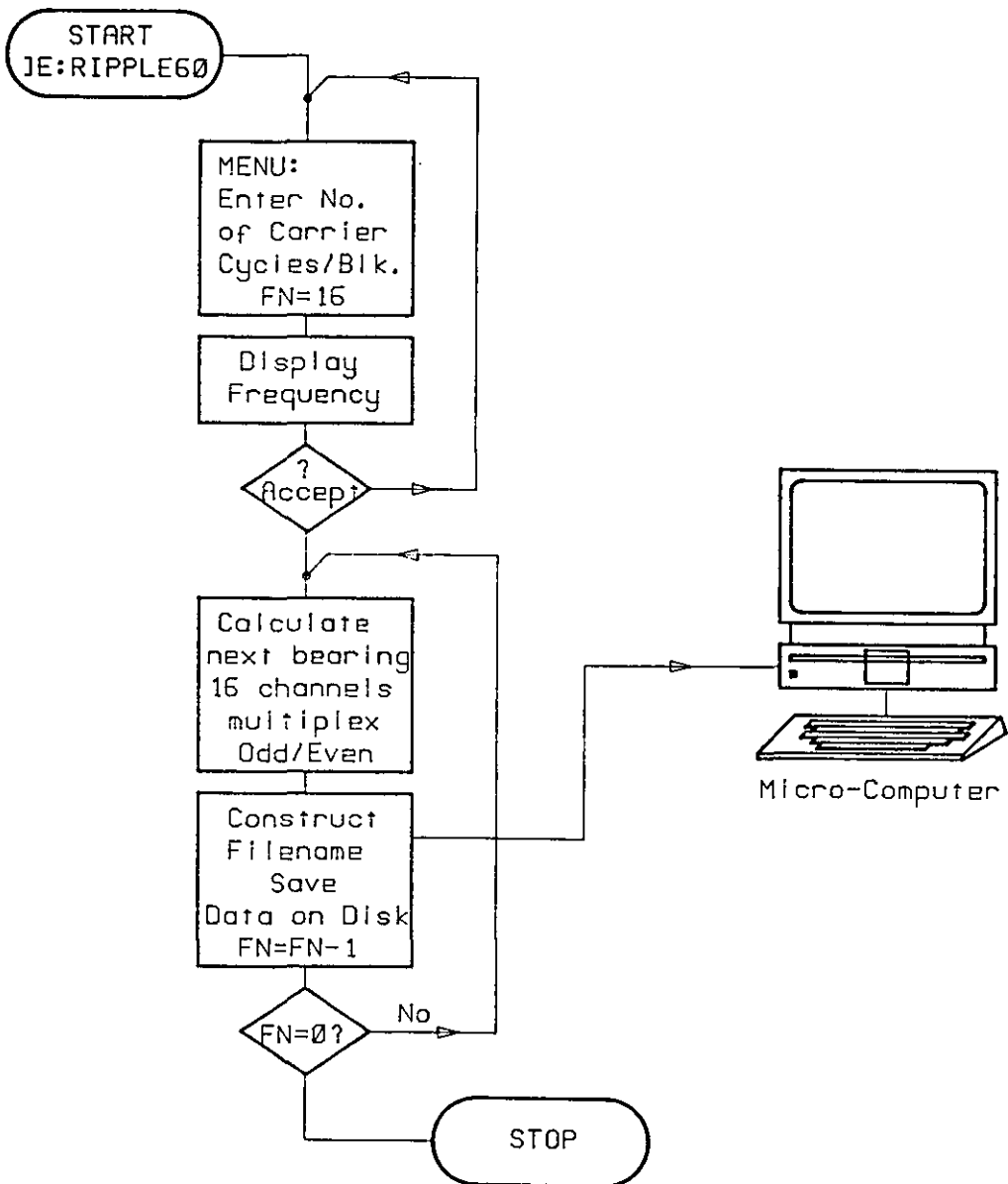

4.4 Program Example - Data Handling and Control.

STEERd.

This is a transmitter control program for the Ripple/Steer/Ping steered modes with the option of amplitude modulation at 0,2,3,4,5 or 6 kHz for steered NLA experiments. The program selects and automatically transfers datafiles from disk into buffer memories for a 30 or 60 degree sector and with modulation as required. (0 = Unmodulated transmission.) The program defaults to an EPROM buffer set of test signals for system checks on initialisation. A menu option is presented when the default settings are to be changed to enable the mode and timings to be selected, i.e. Single bearing Steered transmissions or a Ripplefire of all these bearings across the sector in one contiguous pulse or Ping on each bearing sequentially, stepping across the sector. The menu then sets the transmitted pulse length, the pause period (between transmissions) And then prompts to start transmitting. A single keypress initiates the transmission sequence which continues until a second key is pressed. The option of continuing transmitting, modifying parameters or of loading a new data set from disk is displayed at this time.

Flow Diagram STEERd - Source text listed in Appendix III.

Initial Command:

'JU' - Calls boot sector on disk.

Loads and runs the Object code file mcSTEERd.

Operation:

Links to Pascal machine code disk routines.

Display 1st menu.

Choice:

Load data files - Y/N

Defaults to system test signals stored in EROM for system checks.

Mode set to RIPPLE

Block address set to \$CFFF (EPROM Test routines).

Yes - Display 2nd Menu.

Select steered sector to be scanned 30/60 degrees.

Flow Diagram of STEERd

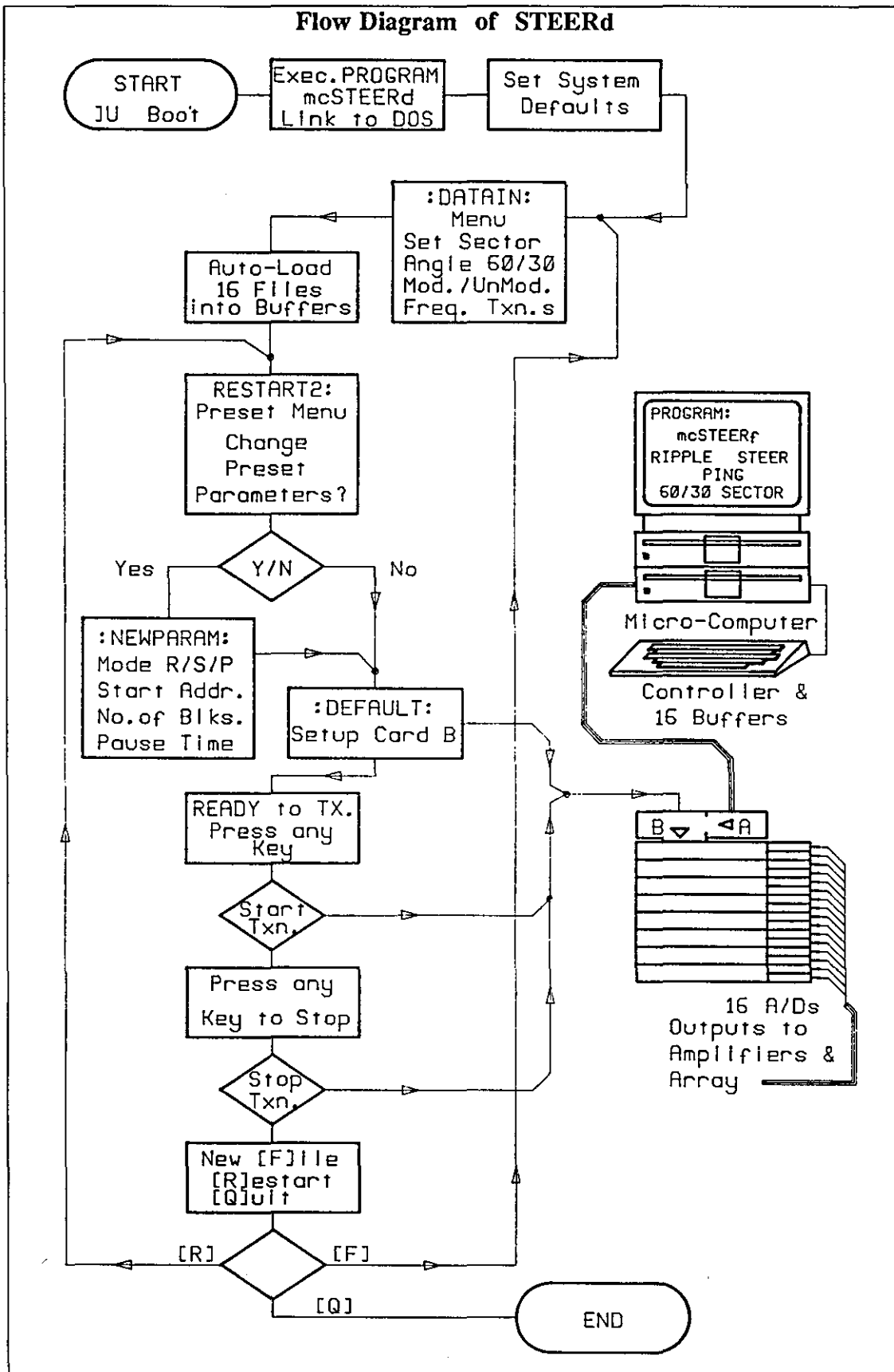

Select modulation frequency - 0 to 6 kHz.

(0 - Unmodulated 41 kHz data steered across selected sector.)

(2 - 6 kHz square wave modulated data for steered NLA.)

Operation:

Compute file name and load sequentially from disk.

(8 files to each set loaded in 33 seconds.)

Display preset parameters.

Choice:

Change parameters. Y/N

N - Ready to transmit (Pause for key press)

Y - Display Parameter menu:

Change Mode : Ripple/Steer/Ping sector

Block Address: Hexadecimal Start of Block address.

Pulse length : Number of block repeats.

Pause period : Select from menu 1 millisecc to 10 seconds.

Preset parameters programmed into control latches

Accept displayed parameters.

Y/N

Ready to transmit (Press any key to transmit)

TRANSMISSION SEQUENCE STARTED

(Press any key to stop)

keypress terminates transmission.

Options:

Change sector / Restart / Quit (to operating system.)

4.5 Summary of Software used for the Lochgoil trials.

Disc ARE01.

This disc contains the STEERd example of the control program which offers the basic modes of operation: STEER / RIPPLE / PING SECTOR. The program selects data files from disk which can steer within a sector either +/- 28 degrees or +/-14 degrees producing unmodulated or modulated signals at 2,3,4,5 or 6 kHz using a 43 kHz carrier. ie. Any of the modulation frequencies in 15 discrete bearing steps of either 4 degrees or 2 degrees.

The control program and all supporting data files are held on one double sided double density disk and a BOOT sector permits the program to be initiated by a simple keyboard entry by the operator.

JU is an in built operating system command to load and execute a 'Bootstrap' program stored on sector 1 track 0 of a diskette in drive 0.

Disc ARE02.

This contains a very similar host program to ARE01, reorganised to offer a selection of 'within pulse' SWEEP modes at rates from 1 millisecc to 7 milliseconds period. In addition the program can also load and run the steered unmodulated data files with the modes of operation: RIPPLE / STEER.

This program utilises 43 kHz data files but does not offer the NLA modulation files.

Disc ARE03.

This disc duplicates all the operations described for ARE01 but uses datafiles computed for 15 degrees and 30 degree sectors.

Disc ARE04.

This disc contains a more dedicated version of the control program STEERf with restricted parameters. The program uses data files computed to produce a centre frequency of 39.75 kHz. The non-linear second harmonic of this signal generated in the water matches the operating frequency of an available 'within pulse' sector scanning receiver and the multi-mode transmitter has been demonstrated to insonify the sector very effectively at long range. The program was modified, and the new frequency data computed, in order

to experiment with a synchronised scanning transmit/receive combination. The control program slightly shortens the transmitted block length, by fixing the MSB address, to ensure the transmission of an integer number of carrier cycles at this frequency.

Disc ARE05.

This disc contains the 'Multi-burst' frequency chirps. Each block contains a different carrier frequency and when ripple fired mode the result is a frequency chirp. Two sets of data are stored on this disc offering a frequency range between 36 and 50 kHz or 10 to 80 kHz. The first band has been used to demonstrate the frequency response of the system.

Disc DataPrep

This disc collates the Pascal source texts of several data preparation programs, including:

RIPPLE60 - Prepares Ripple/Steer data as described above.

SWEEPg3 - This is a similar program which requests a sweep time and computes a set of data files which contain continuously changing bearing data. These files when rippled together transmit a smooth 'within pulse' sweep signal at a pre-determined scanning rate. The maximum pulse length (sweep time) is limited to less than 8 milliseconds by the current configuration of the hardware.

CREATEcp - Generates unsteered data files for a set of carrier frequencies for a chirp or multiburst test signal.

MODIFILE. - This is a general utility program which interacts directly with the steered data files created on the disk by the data preparation programs e.g. **STEERg3**. The program processes each file in turn to produce square wave modulated signals for NLA signal generation. The modified data is then re-filed back onto the disk with a new constructed filename ie **mc8S4mod** where the 5th character refers to the modulation frequency. The modulated data files can be constructed for 2,3,4,5 or 6 kHz and as these are super-sets of the original steered unmodulated data they also generate steered transmissions across the sector. Data required for NLA experimental transmissions.

DISPLAYf - This program accesses a named data file stored on a floppy disc and displays for comparison the first and last 20 samples in each

data 'block'. The display exploits an alternative character set created for this purpose to create a graphic display on the internal VDU without the necessity for a graphic display processor card.

The program prompts for the number of the disk drive storing the data and a filename. The data is read into a buffer and demultiplexed for display as 16 horizontal waveforms. The LSB's of the block are displayed on the left and the MSB's on the right of the screen. As the data is normally output by decrementing the buffer address the transmission starts at the right of this display. DISPLAYf has been very useful aid to check the computed data as the phase relationships at the start and end of each block are very easy to compare on the screen. (See examples in chapter 2).

A MULTI-MODE SONAR TRANSMITTER

Chapter 5 DATA ACQUISITION

5.0 Acoustic Measurement and Trials Range Facilities.

Practical sonar equipment calibration ideally requires anechoic conditions for reverberation free measurements. Acoustic interference from external noise sources within the spectrum of interest should also be zero. However such conditions are quite difficult to achieve in practice. At the higher sonar frequencies small enclosed water tanks, preferably with sound absorbent treatment, are commonly used for measurement work. In such tanks the reverberations from the water surface, tank bottom and sides severely restrict the transmitted pulse lengths that can be used. For lower frequency sonar testing there is little alternative to the use of relatively deep open water conditions. Still water of reasonable depth can be found in lakes and reservoirs, weather permitting. To utilise such places as laboratories for acoustic measurement work also requires a sheltered work room equipped with an adequate electricity supply and a stable transducer support designed to assist in the safe deployment of equipment in the water. Most of these demanding requirements were met for the initial low power trials by the ARE(T) facility on the King George VI reservoir near Staines. The need to establish a test facility close to the University has led to very successful cooperation with the Severn Trent Water Authority who permit us access to the 'draw-off' tower on their reservoir at Foremark in South Derbyshire.

The full power testing of the Mk.2 system required much greater ranges and deeper water than possible at Foremark, and as a result the equipment was redeployed in a Scottish sea loch on board an ARE(LG) floating test facility known as 'Maytime'. This facility is well equipped for acoustic measurement work and staffed by a technical support group. All of these acoustic range facilities have required some specialised array support and handling equipment. The basic parameters of beam width, steered angles, sidelobe amplitude etc. have been measured with the aid of a computerised beam plotting system developed for this project,¹.

5.1 Loughborough University Acoustic Test Tank.

The test tank at Loughborough is an unlined concrete construction approximately 9 x 6 x 2 metres in depth. Heavy duty rails assists the accurate support of equipment and an overhead gantry crane aids deployment and recovery, (fig.5.1:1). Acoustically this tank is highly reverberant and, as the maximum water depth is less than 2 metres, the first multipath echoes arrive at a hydrophone with very short delays over the direct signal. At 40 kHz the achievable separation of 1.2 milliseconds makes it just possible to gate signals for beam width measurement. The second problem at 40 kHz relates to the nearfield of the array. Taking the maximum length of the nearfield zone to be defined by A^2/λ we have: $A=(15 \times 0.04)$; $\lambda=.0365$ for 40 kHz in fresh-water, i.e. 9.8 metres. The dimensions of this test tank are therefore very restrictive for large arrays. However, the ability of the multi-mode transmitter to focus the transmission, by adding an appropriate progressive phase advance to the outer elements of the array, can reduce the Fresnel zone effects. Successful beam plots have been obtained within the tank using this technique to establish the far field beamwidth at short range.

Fig.5.1/1. LUTEE Acoustic Test Tank.

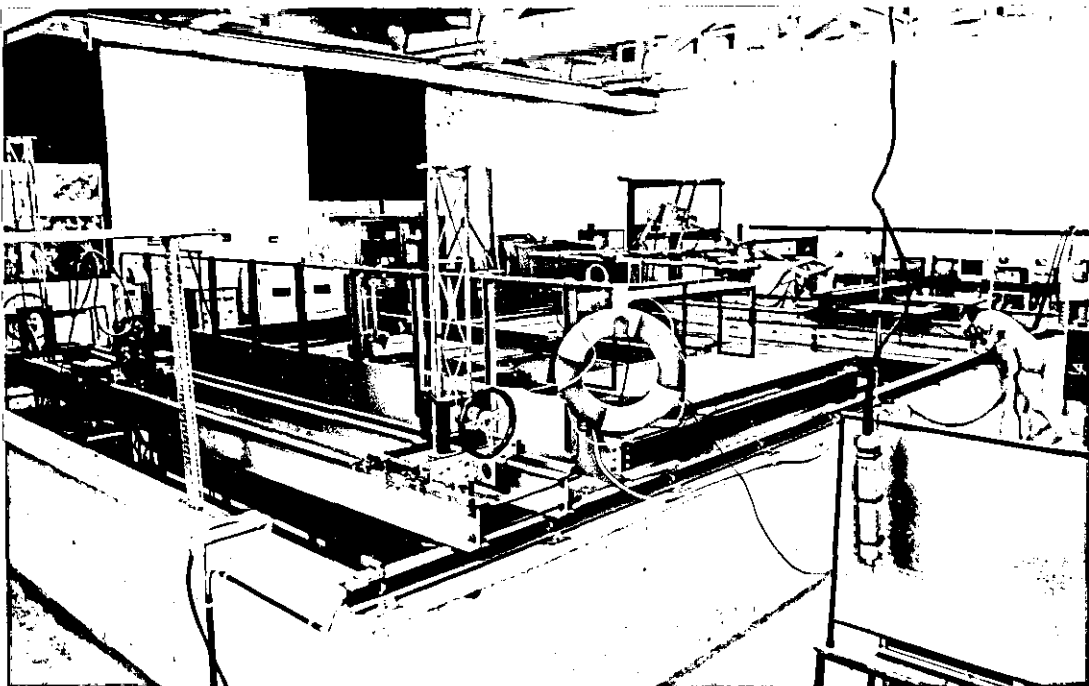

5.2 King George VI Reservoir Trials.

The first open water tests of the multi-mode transmitter equipment took place on the King George VI reservoir at Staines. The facilities available at this site included a raft with mains electricity which is permanently moored some 200 metres from the side. Heavy equipment requires the use of a crane to facilitate transfer from the delivery vehicle to the boat moored against the steep sloping reservoir wall. The raft is fitted with a small jib with block and tackle to assist unloading. The water depth is normally maintained at 14 metres and the available range, depending on the chosen direction, can extend to over 1000 metres. Array testing is facilitated by a centrally mounted electric hoist from which the transducer and training gear can be lowered into the water. The raft's middle floor boards are lifted during deployment and recovery and refitted around the support while working. During deployment the hoist wire is fitted with aluminium slotted tubes which interlock. When the hoist is tensioned these sections tighten into a rigid torsion tube between the array and the rotating head gear, (fig.5.2/1).

In the initial experiments hydrophones were deployed some 30 metres from the raft from a convenient buoyed mooring. However, it proved difficult to maintain a sonar beam pointing accurately at the hydrophone as any wind caused the raft to execute slow angular oscillations about its position. For later trials this problem was largely overcome by the use of a 10 metre carbon fibre pole as a horizontal hydrophone support. This technique ensured that any angular shift in the raft position was tracked by the hydrophone.

The use of Staines reservoir has the drawback of distance from the University which is slightly compensated by the proximity of ARE(T). A more serious disadvantage relates to shared useage. The reservoir also supports three separate trials facilities and significant time can be lost while avoiding acoustic interference to or from other operators.

5.3 Foremark Reservoir - South Derbyshire.

This large capacity reservoir (11×10^9 Litres), completed in 1977, functions as a pumped storage reservoir for Leicestershire's water supply. The original valley contours were widened during the construction of the dam and the final water depth exceeds 30 metres when full. Working from the draw-off tower a deep water path extends for over 1 kilometer with a depth exceeding 20 metres. The very wide valley has required a long curved dam wall

Fig.5.2/1 Trials facility at Staines Reservoir. - Hydrophone support pole deployed.



Fig.5.3/1 Foremark Reservoir and Draw Tower



and a very large sector of water is available to work into. Equipment can be transported by vehicle to the narrow roadway on the dam wall, and transferred to the tower using trolleys to man handle the equipment across a foot bridge, (fig.5.3/1). Transducer deployment is more difficult at this site as the working platform can be several metres above the water depending on the level. A free standing array support, designed by ARE(T) overhangs the water from the work platform,(fig.5.3/2). Large arrays for testing have to be ferried, using a small boat, to a point below this hoist and attached together with the training gear. For stability at depth it was also found necessary to add a large paddle structure above the pan & tilt to absorb the torsional

Fig.5.3/2 Foremark Draw Tower, outer working platform with free standing array support and hydrophone pole.



stress during plotting operations. The supporting cable is fitted with tubing collars, as used on the Staines reservoir facility, and when back tensioned these create a stiff assembly. An additional complication of this external exposed support is its vulnerability to movement in high winds, especially when the reservoir water level is lowered as in fig5.3/2. The support system suffered some damage from surface ice movement during the extreme winter of 1985. Torsional stability was a problem without the stabiliser as the

deployed depth to the array was more than double that available at Staines. A very adequate mains supply (60 amp single phase) was provided inside the tower and security of the electronic equipment left stored inside the tower was good. Working conditions in the winter months leave something to be desired as the structure is impossible to heat.

Hydrophones for the beam plotting experiments were deployed from a stiff fibre glass pole constructed from two 'sailboard masts'. This 10 metre support, deployed horizontally above the water, has worked well in practice, supporting the hydrophones at the edge of the 'far field' of the array.

The Civil Engineering Department at the University conducted a preliminary subsurface survey of Foremark reservoir in cooperation with the Sonar Research Group and the resulting data has made computerised modell-

Fig.5.3/3 Underwater Terrain Model of Foremark reservoir, computed from a limited echosounder survey.

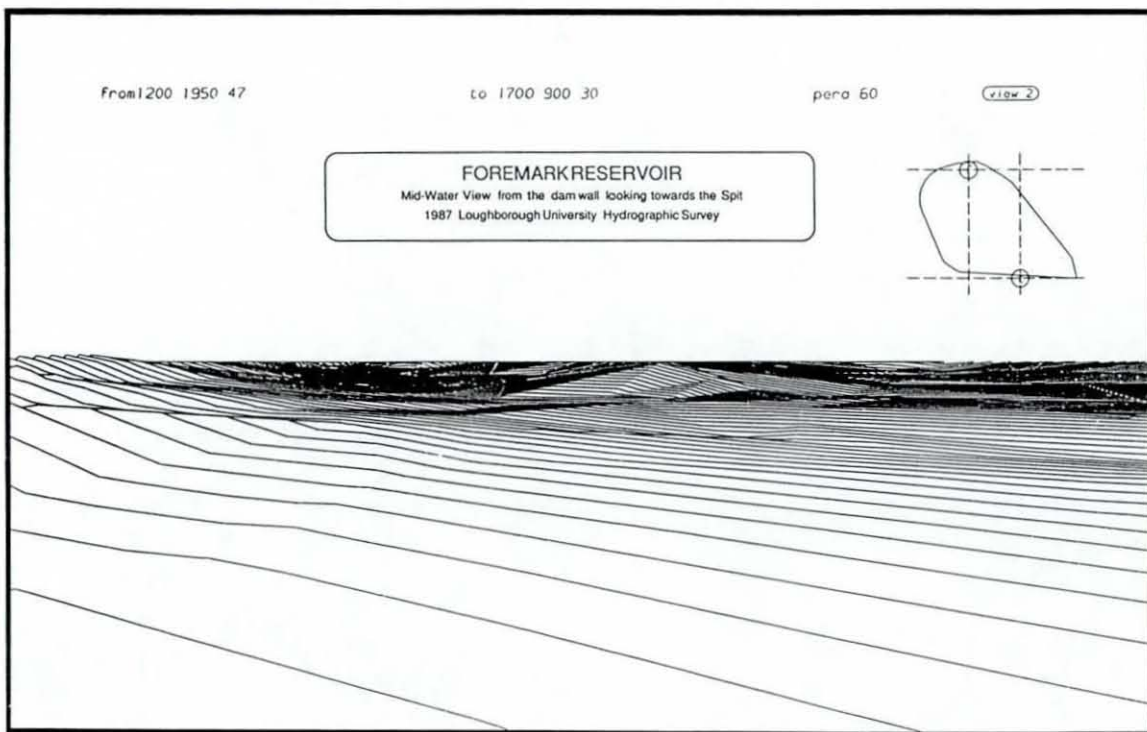

ing of the underwater terrain possible, (fig.5.3/3). These model views should be useful when planning target deployment in future trials. The modelling work was extended to a hydrographic data base supplied for Lochgoil and is proving to be a very useful aid when interpreting the long range reverberant echoes.

5.4 Maytime, Lochgoil.

This is an Admiralty Research Establishment facility constructed from an enclosed barge which is semi-permanently moored in relatively sheltered water 60 metres deep, (fig.5.4/1). The site is equipped with hydraulic cranes to assist in array deployment and although several hundred metres from the shore it is connected to the mains with both single and three-phase feeders. A professional boat crew is normally available to assist in the deployment of hydrophones and targets as required and technicians of the Technical Support Group are available on board to organise the facilities.

Acoustically, the maximum range visible from 'Maytime' is limited by the geography of the glaciated valley to approximately 4 kilometers of deep water. The Royal Navy Hydrographer at Taunton made available a recent detailed echosounder survey and this data has been digitised on the University's mainframe computer and used as a data base for some interesting 3-D perspective modelling of the Lochgoil subsurface terrain,². These models have assisted in the interpretation of echo returns from the geographic features which characterise the reverberation on this range. (fig.5.4/2,3). Currently the Mk.2 multi-mode transmitter equipment is

Fig.5.4/1 'Maytime' Acoustic trials facility in Lochgoil.



Fig.5.4/2. Computed Terrain Model. Perspective view of Lochgoil as seen from the transducer position at 30 metres depth.

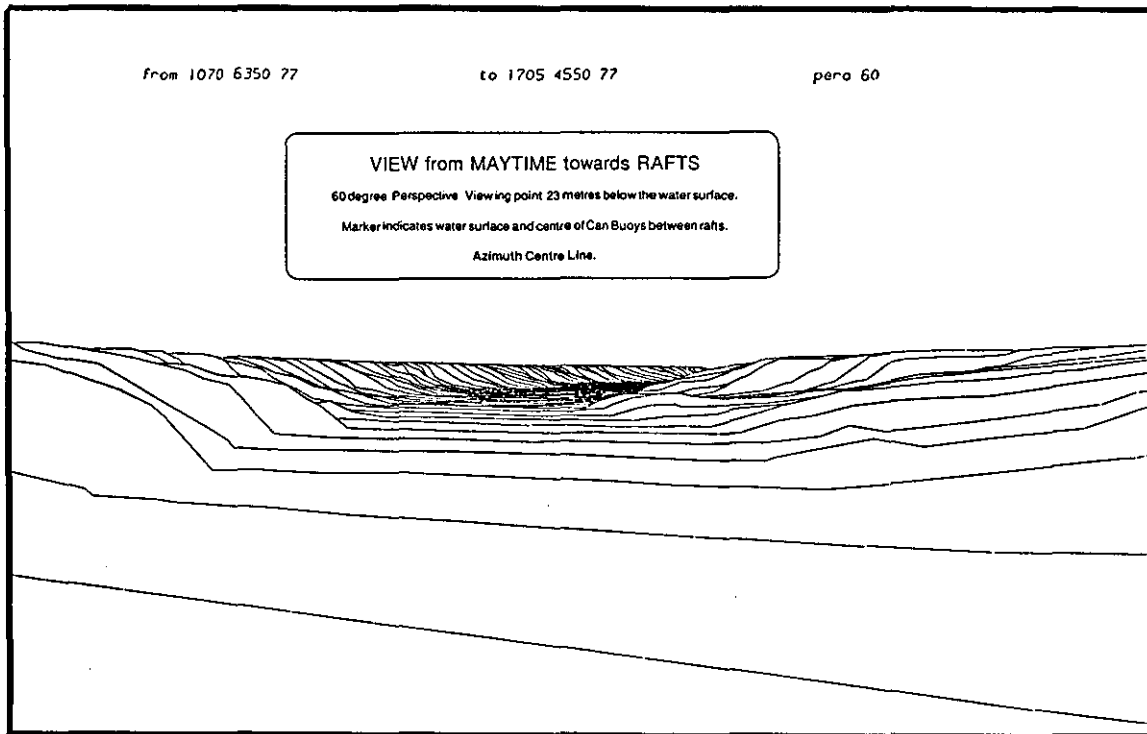
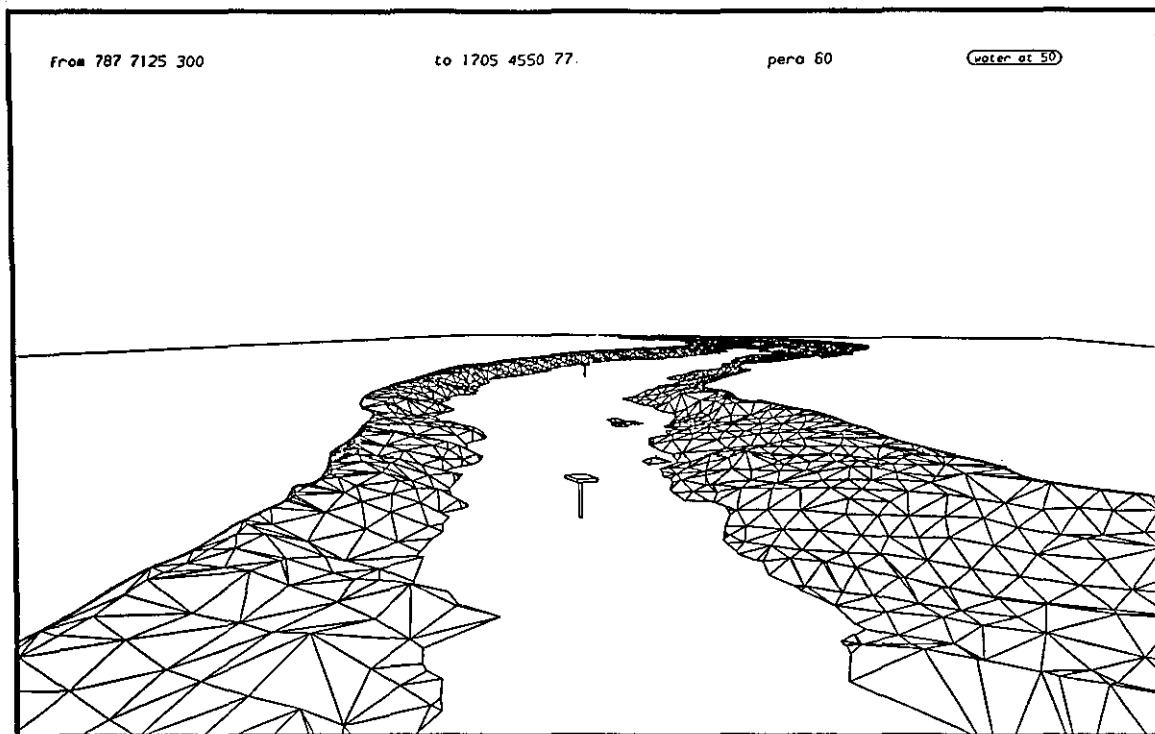

Fig.5.4/3. Lochgoil Modelled from above the end of the loch. The sea level has been removed to a depth of -50 metres.



deployed in Lochgoil to assist continuing research into the parametric non-linear modes of sonar emission.

5.5 Sonar Receivers.

The multi-mode transmitter was conceived as a stand alone research tool with which to experiment with phased array techniques. The acoustic measurements of performance have in the main been made using standard commercial hydrophones. For certain measurements wideband low noise pre-amplifiers were constructed as were several passive bandpass filters. The mechanically scanned images, made at Foremark reservoir, utilised the display equipment developed for synthetic aperture experiments³. This equipment required some modification and the addition of a preamplifier, bandpass filter and detector stage. No TVG or RCG signal processing was used in the reservoir measurements and although these facilities have now been developed for the scanning receiver they are not detailed here. The high power trials in Lochgoil benefitted from access to the wide range of commercial receiver and signal processing equipment installed on board. To fully exploit the multimode transmitter's capability as a scanning sonar system will require a matching 'Transcan' receiver to decode and display the bearing information from a single input channel. Equipment for such a receiver is being developed and the basic idea for this concept is outlined in chapter 7.

5.6 Hydrophones and Preamplifiers.

A variety of hydrophones have been used during this research, however a 20 mm diameter ball hydrophone (Universal Sonar Ltd.) was used as the reference hydrophone for most of the reservoir trials. This hydrophone was calibrated at R.D.V.Crystal, (ARE Portland) and has an acceptably flat response to well above 80 kHz. Other devices included lower frequency ball hydrophones D1/40, D1/70, D1/80 (Universal Sonar), a precision PVdF plate hydrophone from EMI⁴ and an experimental PVdF Vibetec device (Raychem Ltd). Use of a single stave of the Mk.2 array as a directional receive hydrophone also gave very good results in the reservoir trials. The hydrophones used in the Lochgoil experiments included B & K hydrophones (BK8100), several experimental (F.E.A.) active hydrophones, a vertically deployed line array and a vertical 10 x 2 array of ORE 3 kHz low frequency elements. The later is now being used in the parametric scanned sonar experi-

elements. The later is now being used in the parametric scanned sonar experiments as it provides some useable receive directivity in the vertical plane for the low frequencies of interest.

For most of the initial trials the signals recovered from the hydrophones were at very high amplitudes and no buffering or amplification was required for oscilloscope display or for beam plotting.

Low noise battery powered preamplifiers were required in the reservoir trials when examining echoes from target spheres at 300 metres and also when plotting the far shoreline at 1 kilometer. Several unsophisticated preamplifiers were constructed for these trials with the design emphasis placed on low noise and low distortion performance. As the performance of most of these designs are detailed in the LUTEE internal reports they are not re-examined here, ⁵.

5.7 Data Logging and Signal Analysis Equipment.

A variety of wide band oscilloscopes have been used to display the hydrophone signals for amplitude measurement. The close range measurement technique employed permits a rapid transmission rate and waveform examination is eased as a result. Echo signals from longer ranges can only be examined at slower rates and a Gould digital storage oscilloscope was acquired capture the transient data. The storage parameters of this equipment, 2048 samples at a 200 kHz maximum sampling rate, are unfortunately rather close to the 40 kHz transmissions and problems of aliasing frequently occurred with some time base setting. To avoid problems of this nature Polaroid photographs of the wideband oscilloscope displays have been used for much of the transient data capture.

Digitisation of the received signals for computer processing and storage has been employed in the beam plotting equipment, Appendix II. The gated hydrophone responses are converted to 10 bit digital samples in a BBC microcomputer. The data being available as an on screen graphical display of the beamplot or as a data file for hardcopy and subsequent analysis.

The mechanical scanned sonar images of Foremark reservoir were obtained by a modified Synthetic Aperture Receiver and, although digitised to 8 bit accuracy, were stored for display in a 6 bit framestore. The data was written to disk and displayed simultaneously on the TV monitor as it was

received. The disk images could be processed off-line to generate colour amplitude coded hardcopy.

At the Lochgoil facility, on board *Maytime*, a Hewlett Packard Dynamic Analyser was available. This equipment facilitates waveform capture and the analysis of spectral components for short data samples. The 8 bit resolution system, when set for a 0-100 kHz analysis band can capture and display a 4 millisecond window of data. The images generated are displayed on the built in monitor and can be hardcopied directly to a plotter. The last few trials depended on this machine for much of the data analysis made at the time and it will be even more important in the future NLA experiments.

Portable recording equipment of adequate bandwidth for 40 kHz has not been available although this is a desirable facility. A Nagra IV recorder offering a maximum frequency response of 32 kHz at 38 cm/s has been used to obtain examples of the non-linear acoustic effects.

Recordings of the Multi-mode sonar transmissions, made by ARE(T) staff using an Ampex PR2200 at Lochgoil, have been duplicated for replay on a older FR1300 machine at Loughborough. These instrumentation recorders are both capable of recording the 40 kHz carrier and 80 kHz harmonic responses generated by the multimode transmissions as the necessary wideband response is possible using the direct record modes. However, most of the data recordings concentrated on the low frequency NLA transmissions using the FM record mode to obtain the best signal to noise ratio for later analysis.

The acquisition of a very high resolution speech spectrograph ⁶ has proved an invaluable tool for the analysis of the recorded NLA signals. The equipment is extremely flexible and produces colour coded hard copy. The spectrograph can analyse signals into 25 Hz bands if required, however the internal anti-aliasing filters are set for an upper limit of 8 kHz. Much higher frequency data than this can only be examined by using tape speed transposition techniques but the spectrograph is of most use at the lower frequencies.

A MULTI-MODE TRANSMITTER

Chapter 6 TRIALS RESULTS

6.0 Initial System Tests - Beamforming and Focussing

The Mk.1. low power system, comprising a 15 element line array, 130 watt channel amplifiers and the multi-mode signal synthesiser, was taken to Staines reservoir for the initial open water tests.

The first beam plots, made with the LUT computer controlled pan and tilt, demonstrated that the system functioned acceptably close to theory. The unsteered main lobe approximated 4 degrees in beamwidth, the sidelobes were a little irregular but the beam pattern with endfire lobe positions appeared as predicted by the inter-element spacing and operating frequency, i.e. at 75° off axis rather than 90° , (Chap.2). These first beam plots suffer from some underwater acoustic interference, believed to be sonar transmissions originating from an adjoining raft.

The hydrophone used for these plots was hung from the end of a 10 metre long supporting pole, deployed from the side of the raft moored on Staines reservoir. The 15 element array was supported from the centre of the raft and the distance between the array and the hydrophone was 15 metres. Both the transducer and the hydrophone were deployed midwater at 7 metres depth, (fig.6.0/1). The hydrophone response, plotted while the array was mechanically scanned through an angle of 200 degrees, is shown in fig.6.0/2. The transmitted data in this example is the same in all channels and therefore unsteered. The endfire response is acceptably low and can be compared with the computer model of this array shown in chapter 2, (fig.2.0/2). Individual channel power adjustment was achieved by preselecting resistors values to generate equal amplitude responses from each stave at the hydrophone. This method of adjustment proved to be an unwieldy time consuming operation. Optimum channel matching was not achieved for the first trials as is evidenced by the asymmetry visible in the first order sidelobe responses, (fig.6.0/3). The beam width of the main lobe was measured several times and averaged close to the expected 4 degrees. Subsequently the channel matching adjustments were simplified by the addition of a 'plug in' attenuator card

Fig.6.0/1 Beam plotting arrangements at Staines.

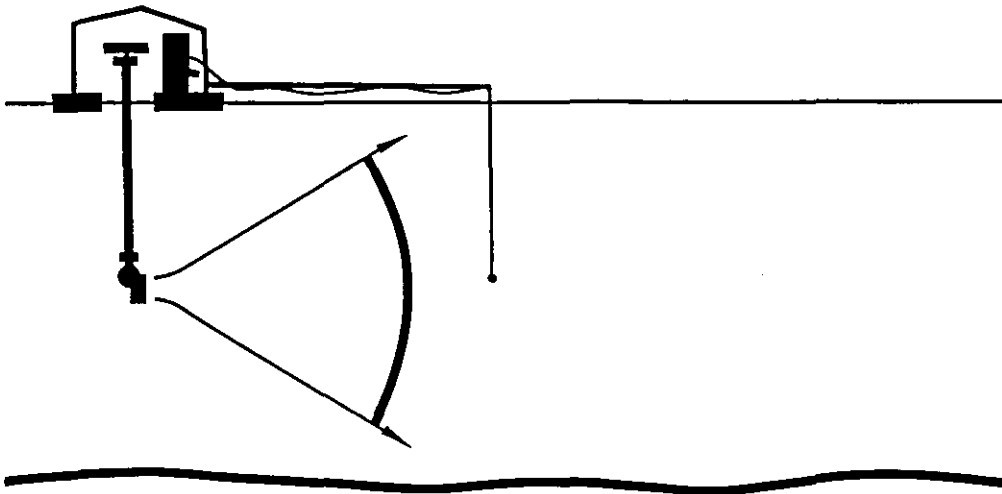

Fig.6.0/2. Mk.1. Array Beam Plot, 200 degree scan.

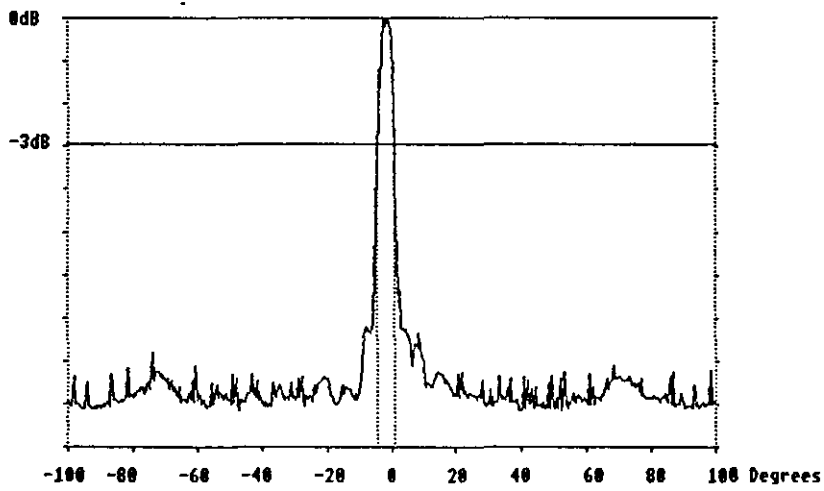
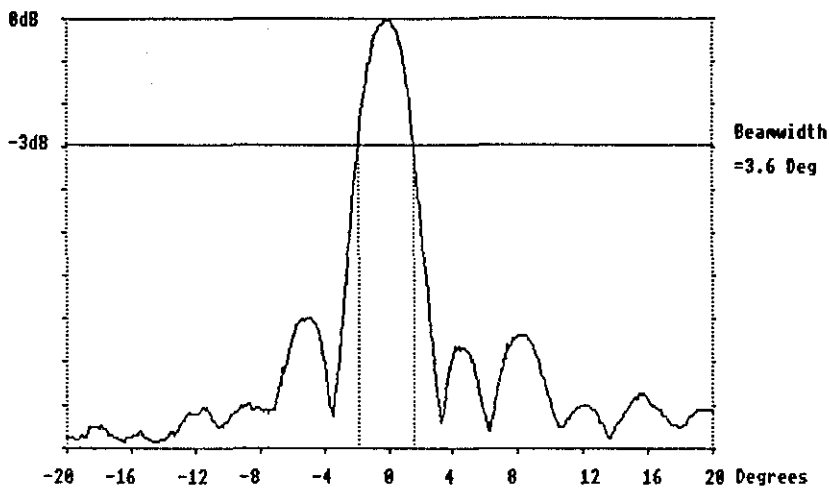

Fig.6.0/3 Mk.1. Array Beam plot, 39 kHz, 40 degree sector.



and a test signal transmission mode developed which ripples through each channel sequentially as shown by the signals in chapter 2, fig.2.8:1,2.

Some difficulties were experienced as a result of the size of nearfield when attempting to plot the far field performance of the array. Using a 15 element array of nominally one lambda pitch at 40 kHz implies that the far field is not fully formed until the measurement point is placed at least 9 metres from the array face.

i.e. if the start of the far field is taken to be approximately d^2/λ

In freshwater using the Mk.1 array's actual inter-element dimensions:

15 elements (each with a diameter of approximately λ)

pitched at 40 millimetre spacing gives an aperture of 0.6 metres.

The length of the near field therefore approximates to:

$0.6 \times 0.6 / .0365 = 9.9$ metres at 40 kHz

The Mk.2 array also has the same aperture.

(16 staves pitched at 0.0375 also equals 0.6 metres):.

In either case it is evident that the University test tank dimensions are too small to attempt to establish the array's farfield beamwidth. However, as noted in Chapter 2.4, the introduction of an acoustic lens between the array face and the measurement point can significantly alter the fresnel zone dimension. Choosing a lens with suitable positive focus can effectively shorten distance at which the farfield pattern can be determined. A simple emulation of this lens effect can be achieved by advancing the phase of the outer elements in the array to correct for the increased path lengths so that all the element contribute in phase at the hydrophone distance. The concept has been tested successfully with computed focus points at various ranges within the near field. A very small focus correction (9 metres) was applied to the signals measured at Foremark to ensure that the limited length of the pole supported the hydrophone in the farfield. In the Test Tank focussed data for 2 metre and 1 metres range has been tested successfully. Fig.6.0/4 demonstrates a beam plot made using unfocussed data at 2 metres range showing that the array directivity is seriously impaired within the nearfield of the array. Repeating the experiment at 2 metres using a focussed data transmission, fig.6.0/5, demonstrates that a well formed beam pattern now exists which matches the beam patterns measured during the reservoir trials in the 'true' far-field. The technique has an additional advantage of generating very high

Fig.6.0/4

Beam Plot of the Mk.1 Array
at 2 metres range.
Inside the near-field.

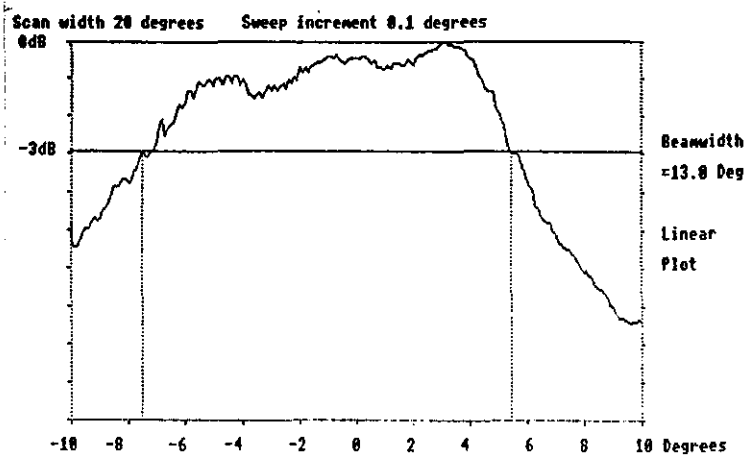
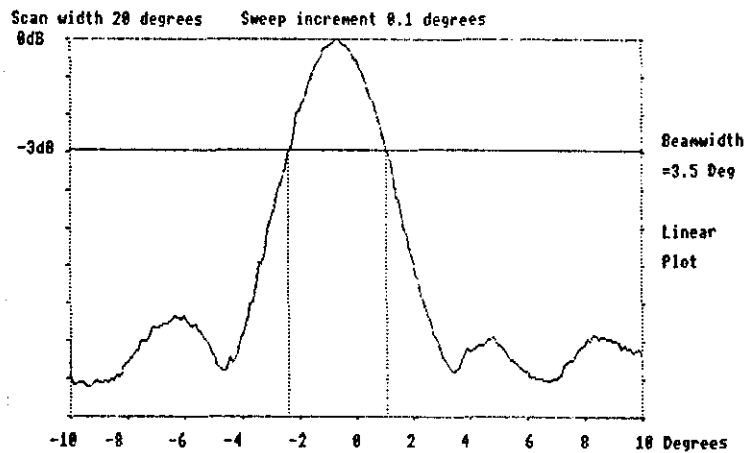

Fig.6.0/5

Beam Plot Mk.1 Array
at 2 metres using
focussed data.



source levels at the focus, permitting cavitation levels to be reached without excess stress at the transducer face.

6.1 Beam Forming and Shading.

The theoretical beam pattern, predicted for a 15 element 1 lambda pitch array, within the +/-30 degree sector when all the elements contribute equally is shown in fig.6.1/1. A variety of shading techniques exist in the literature which are designed to reduce the amplitude of the unwanted sidelobes. One of these, based on the Dolph-Chebyshev polynomial, is of particular interest as it can be applied by amplitude weightings distributed across the array aperture without needing phase reversals. The technique permits all the sidelobes to be reduced to a specified amplitude and this reduction ratio is gained at the expense of the primary beam width and source level. The theoretical response for a 20:1 sidelobe ratio is shown in fig.6.1/2.

Using the Mk.1 system with its 15 element array, an experimental investigation of a Dolph-Chebyshev shaded array was undertaken with rather disappointing results, (fig.6.1/4). However the unshaded beam pattern from

Fig.6.1/1

Theoretical Beam Pattern of a
15 element 1λ array.

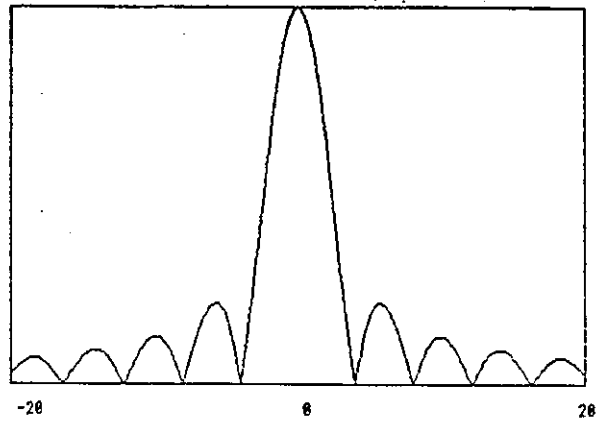

Fig.6.1/2

Theoretical Beam Pattern of the
Dolph-Chebyshev (20:1)
Shaded Response.

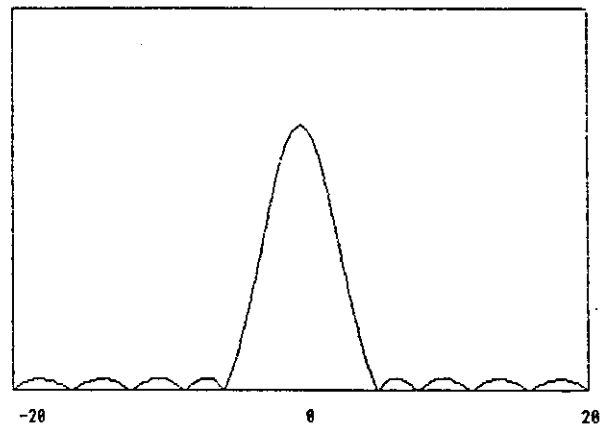

Fig.6.1/3

Unshaded Beam Pattern
Plotted using the
Mk.1.array.
38 kHz

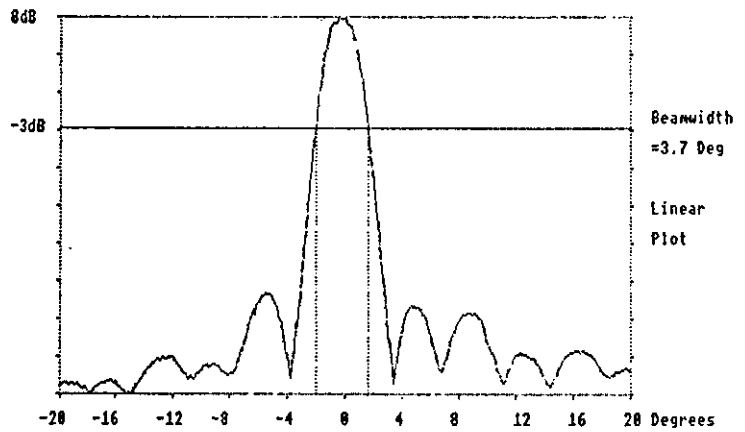

Fig.6.1/4

Modified Beam Pattern
obtained using
Dolph-Chebyshev
shading parameters.
38 kHz

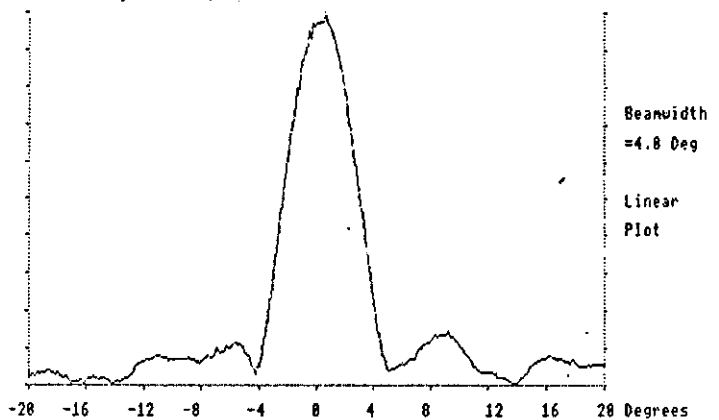

Fig.6.1/5

Theoretical 15 element
 1λ response modelled
with Mk.1 array
phase errors added.

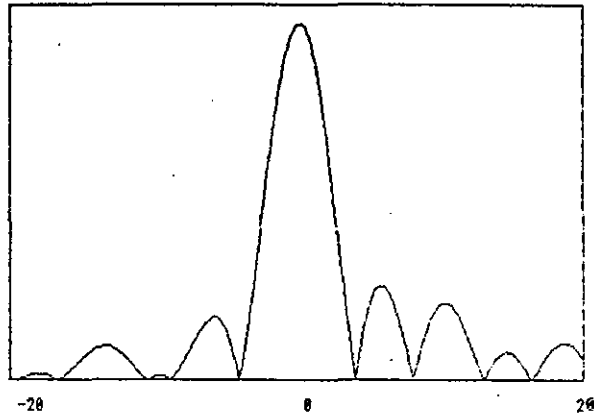
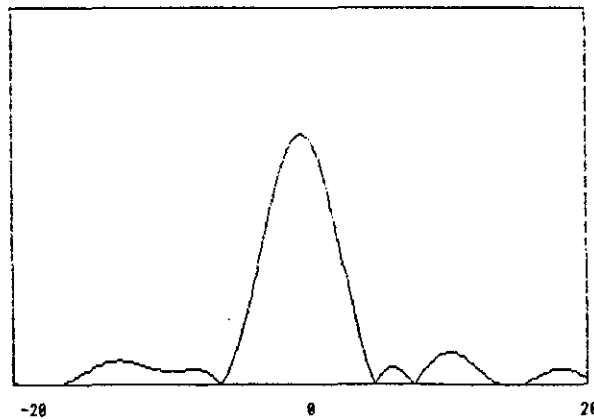

Fig.6.1/6

Theoretical 15 element
response with phase errors
and Dolph-Chebyshev
weightings.



this array is rather asymmetrical (fig.6.1/3) and a careful investigation of the phase responses of each element demonstrated significant variations in the mechanically defined phase of the piston transducers. The theoretical array responses were recomputed to include the measured phase deviations and the modified predictions are much closer to the practical plots. The phase corrected but unshaded predicted pattern, fig.6.1/5, and the corrected and shaded version, fig.6.1/6, demonstrate that the Dolph-Chebyshev shading concept offers useful advantages if the inter-element phase errors are very small or can be compensated for. The use of 4 bit resolution data in these preliminary experiments limited the precision available to define the necessary amplitude and phase and further work on shading techniques was deferred until an 8 bit system could be employed.

6.2 Beam Steering.

Beam steering is implemented by computing the requisite phase delays for each transducer channel. Beam plotting the resulting array response, to establish the positions of the peak and sidelobes, is achieved by

mechanically turning the array while transmitting the phase shifted data and recording the hydrophone output. Sets of disk files containing steered data in 4 degree steps were prepared off-line. Each file was then used to generate a sonar transmission aimed at the specified angle and its beam pattern plotted.

Log Plots of steered transmissions using the data files for 8° , 16° and 28° off axis are included in figures 6.2/1,2,3 demonstrate the effect.

Further data files were computed for 2 degree and for 1 degree steered increments i.e. steering within 30 degree or 15 degree sectors. Later versions of the control programs prompt for a sector angle and automatically load the selected steered data sets.

Fig. 6.2/1

Mk.2.array 43 kHz Transmission

Log. Scale Beam Plot

Steered Data.

8° phase shift.

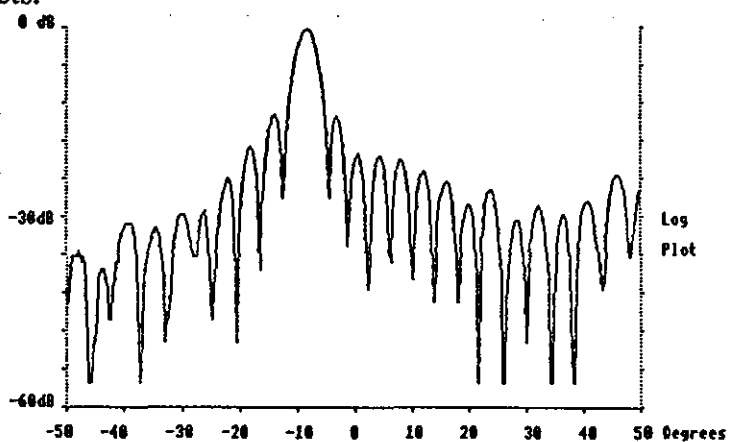

Fig.6.2/2

Mk.2.array.

Log. Scale Beam Plot

Steered Data.

16° off-axis.

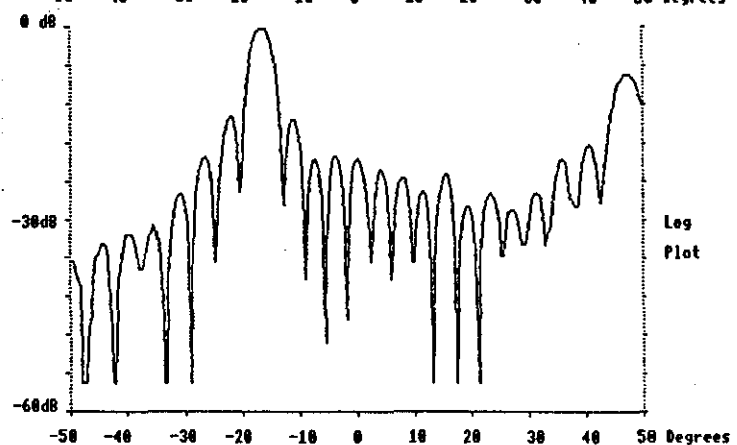

Fig.6.2/3

Mk.2.array.

Log. Scale Beam Plot

Steered Data.

28° off-axis.

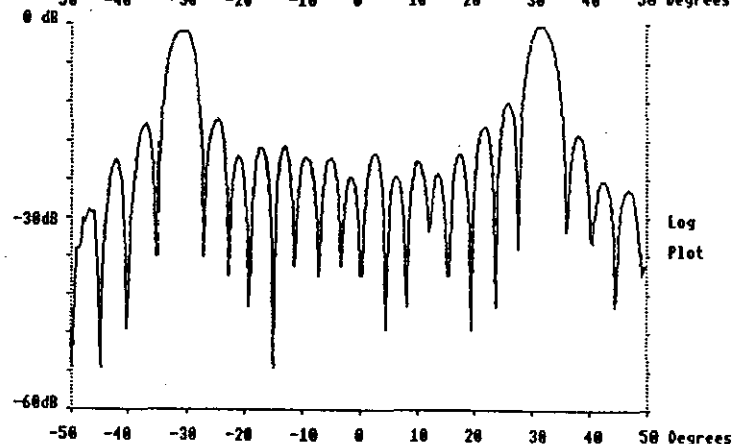

6.3 Sector Scanning. - Ripplefire and Sweep Modes

Two methods of scanning a sector have been developed. The first, referred to here as 'Ripplefire' utilises a stacked set of the steered data described in 6.2. The name 'Ripplefire' was taken from naval gunnery terminology as the similarity to that operation illustrates how sequential transmissions on each bearing join to appear as one contiguous pulse. The sector is scanned in discrete bearing increments as a beam plot of the combination transmission demonstrates, (fig.6.3/1).

The pulse length transmitted on each bearing can be programmed to be of any length, however the total pulse length is the sum of all the individual bearing components and a timing 'slew' across the sector is unavoidable. The technique can be altered to introduce the listening period between each bearing transmission, simulating a 'ping and listen' mode which

Fig.6.3/1 Linear Beam plot of a Ripplefire transmission.

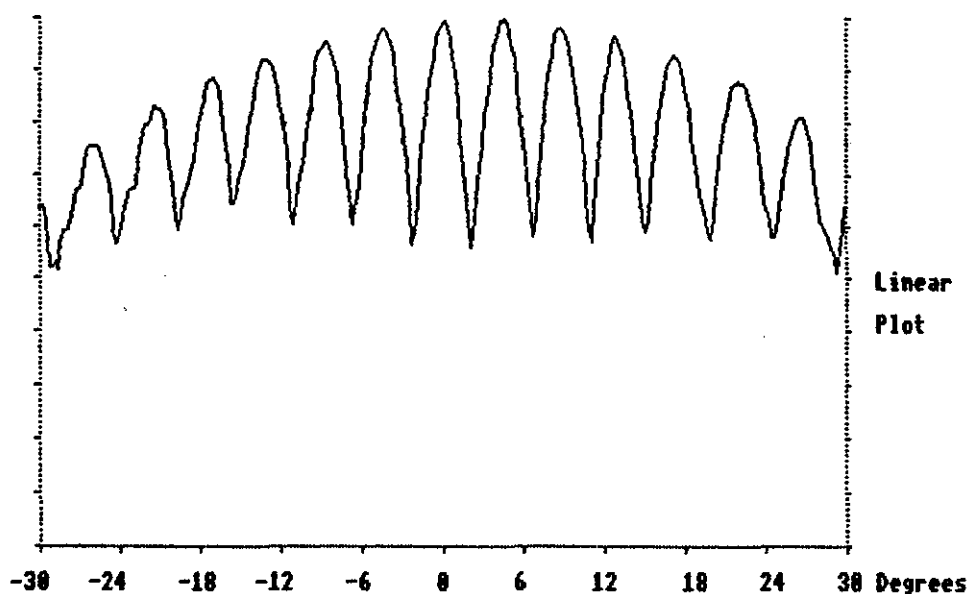

'walks' across the sector. The bearing data can also be stacked in any order for transmission should it be desired to randomise the scanning sequence.

The second method generates a smooth sector scan by continuously changing the phases between each channel. i.e each channel is driven with a different frequency, the sweep rate is defined by the difference frequency between adjoining elements. Fast sweeps imply large difference frequencies and hence the element bandwidth rapidly becomes a limiting factor with increas-

ing array size. For a lambda pitch array a difference frequency of 1 kHz is needed between each transducer to sweep the beam across the sector in 1 millisecond. A 15 element array requires elements with bandwidths adequate to accomodate frequencies +/- 7 kHz about the centre frequency. This 15 kHz bandwidth, centred on 40 kHz, necessitates wideband transducers with a 'Q' in the order of three! The Mk.1 array, constructed from narrow band elements, generates rather distorted beam patterns when driven at sweep rates faster than 2.5 milliseconds. The Mk.2 staved array, which utilised wideband elements, has been shown to produce acceptable beam patterns with a variety of sweep rates down to 1 millisecond, (fig.6.3/2,3,4).

Fig.6.3/2.

Mk.2 Sweep Pattern

Hydrophone response to a (multiple)

4 x 1 ms Sweep transmission.

0.5 ms/div

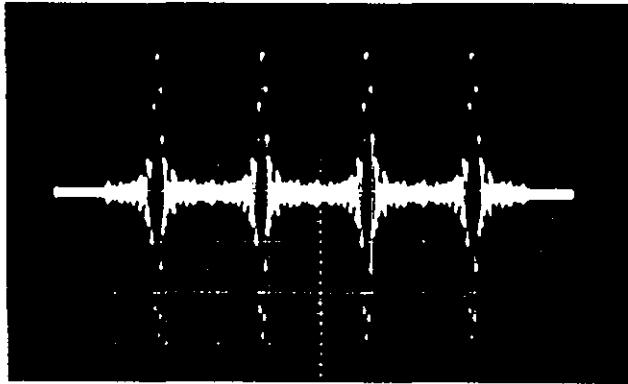

Fig.6.3/3

Mk.2 Array Sweep

Hydrophone response to a

7 millisecond sweep.

1 ms/div.

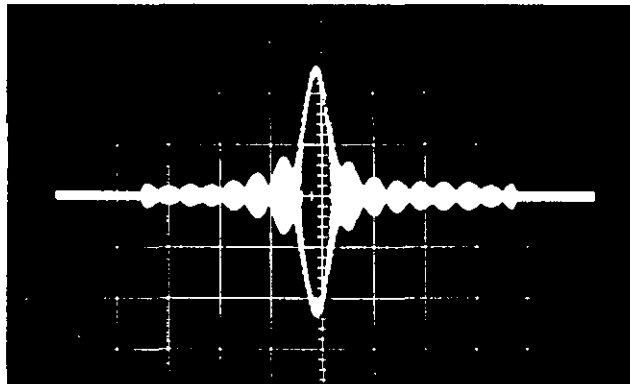

Fig.6.3/4

Mk.2 Array Sweep

Hydrophone response to a

7 millisecond sweep.

Hydrophone placed at 30 degrees away from the centre axis to show the equal ambiguity lobes.

1 ms/div.

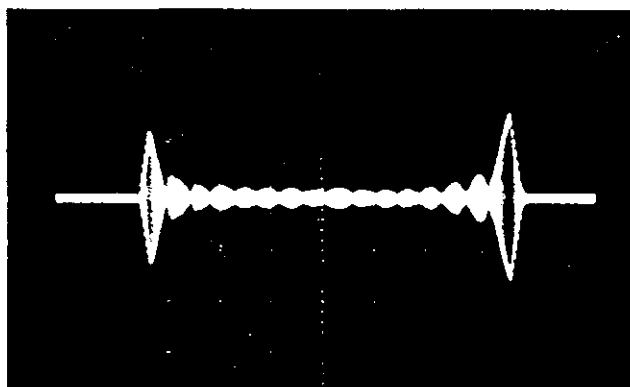

These sector scanning modes were investigated using the Mk.2 array which was used to generate scans of a 60 degree sector at the 40 kHz primary and at the non-linear product frequencies. The Ripplefire mode permits long pulses to be developed which can be frequency coded to assist bearing discrimination. It was noted during these experiments that the NLA enhanced 2nd harmonic of the swept signal at 80 kHz proved to be a particularly effective insonification source when exploited in conjunction with a conventional 'within pulse' scanning receiver.

6.4 Source Levels and Non-Linear Acoustics.

The Mk.1. low power system demonstrated that detectable non-linear signals could be obtained from a 2 kilowatt transmission.

Experiments at Foremark with the Mk.2. equipment running at 10.5 kW confirmed this. Directly recorded signals at 800 metres range were made using a Nagra IV portable recorder and the data replayed through a spectrograph,². At this range the 40 kHz square wave modulated transmission

Fig.6.4/1. N.L.A. transmission spectrum. Analysed from data recorded at 800 metres down range.

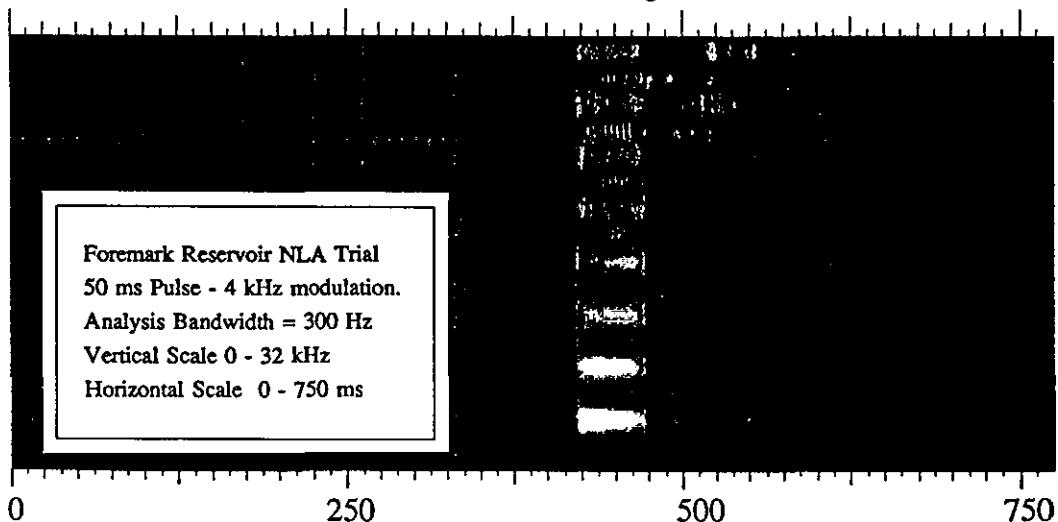

was expected to generate a significant low frequency component in the water at the modulation frequency. The recorded signals were carefully kept well below the tape distortion levels and the hydrophone response was filtered to reject components above 30 kHz. The spectrogram (fig.6.4/1) demonstrates the presence of the low frequency 4 kHz component and its harmonics at 8, 12, 16kHz etc.

Fig.6.4/2 Foremark experimental determination of the 4 kHz Non-linear beam width.

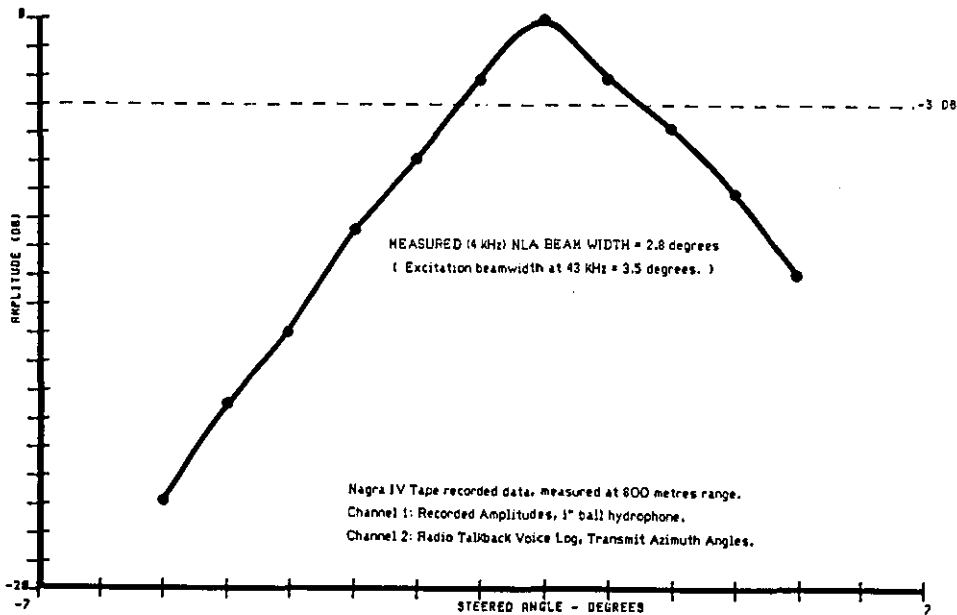

The Non-linear beam width was also measured at this time by recording both the hydrophone signal and, via a radio link, the simultaneous voice log calling the steered angle as the array was rotated in small increments. The replayed data was then measured and plotted manually (fig.6.4/2). this experiment indicated that a 4 kHz non-linear beam with a -3 dB width of approximately 3 degrees was formed from a 43 kHz primary at 800 metres range.

To assess both primary and non-linear source levels obtainable in Foremark the transmissions made from the tower were intercepted at ranges greater than 350 metres using a hydrophone deployed from a boat. The received signals were displayed on an oscilloscope and polaroid photographs recorded the traces. This experiment was repeated on four occasions but severe weather conditions caused the boat and hydrophone to move excessively and the accuracy achieved was limited.

The technique evolved to minimise stability effects utilised a ripplefire transmission computed for a 15 degree sector. This ensured that the hydrophone deployed from a moored boat remained within the overlapping beams to accurately record the peak amplitude. The buffered hydrophone signal was fed to a selectable set of passive narrow band filters, with known insertion losses, in order to measure the relative amplitude components of the signal at the spot frequencies 40, 80, 4, and 8 kHz.(6.4:1). The dual trace os-

illoscope, powered by a battery inverter in the boat, was used to simultaneously display the filtered primary and one of the selected non-linear frequencies. Polaroid photographs were taken from the oscilloscope display and the peak amplitudes for each filtered component logged. The results from one of these trials, analysed in 6.3, indicated a primary source level at 40 kHz of 243 dB ref 1 μ P. Taking the reduced power used to drive the array in Foremark (10.5 kW) into account this result seems to be in reasonable agreement with the later experiments at Lochgoil using the full 16 kW transmission from which a 245 dB source level was realised.

6.5 Source Level Results (Foremark trial 13-5-87).

Measuring hydrophone deployed at mid-water from a boat at 375 metres range. Vertical beam width 4 degrees; Water depth 17.5m; Temperature 6°.

Signal insonifies the full water column after 250 metres range.

40 kHz	180 mV p/p	-15	dB (ref 1 V)
80 kHz	35 mV p/p	-29	dB
4 kHz	*3.2 mV p/p	-50	dB
8 kHz	*0.45 mV p/p	-67	dB

[* Corrected for +55 dB, post filter, amplification.]

(Filter insertion loss at 40 kHz	=	7	dB)
(RMS conversion from pk/pk	=	-9	dB)
Combined effect	=	-2	dB
40 kHz Signal	=	-17	dB ref 1 Volt
D140 Hydrophone sensitivity {ARE(P)}	=	-90	dB ref 1V/Pascal.
Pressure at hydrophone	=	73	dB ref 1 Pascal
Spherical Spreading 0-250m : $20 \log(250)$	=	48	dB
Cylindrical Spreading 250-375m : $10 \log(375/250)$	=	1.8	dB
Absorption loss (1.25 dB/ km @ 6°) =		0.5	dB @ 40 kHz.
(Total loss 48+1.8+0.5	=	50	dB)
Referred to 1 metre gives	=	123	dB ref 1 Pascal.
40 kHz Source Level	=	243	dB ref 1 μPascal.
Absorption loss @ 80 kHz (3.7 dB/km).=		1.5	dB
80 kHz Source Level	=	230	dB ref 1 μPascal
At 4 kHz and at 8 kHz the absorption loss is assumed to be negligible.			
4 kHz Source level	=	208	dB ref 1 μPascal.
8 kHz Source Level	=	191	dB ref 1 μPascal.

6.6 Reference Target detection - Foremark.

A standard -18dB target sphere was deployed at 300 metres range in Foremark reservoir at approximately mid-water. The water depth at this range was approximately 18 metres, as can be seen from the echosounder chart in fig.6.6/1. (The reservoir was artificially low at this time due to reconstruction work on the dam.) The Mk.2 array, driven with 10 kilowatts of electrical power, was configured to use only 15 of the 16 channels. The 16th stave of elements was used as a matched hydrophone and the array mechanically

Fig.6.6/1 Midwater reference target

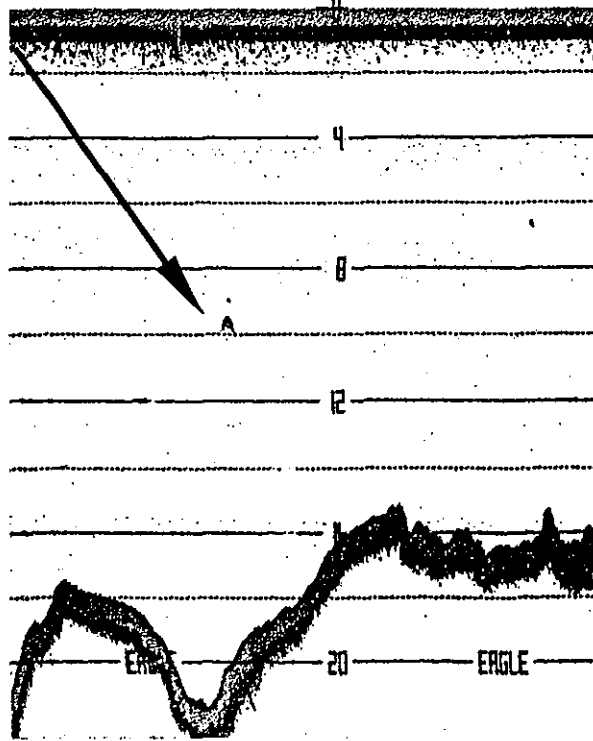

panned onto the target. The received echoes were preamplified and envelope detected using an operational amplifier 'precision detector' circuit and then low pass filtered before being displayed on the oscilloscope. Fig.6.6/2 is a polaroid of the display from a single 5 millisecond 43 kHz transmission made with the array horizontal, the ripple in the pulse envelope suggesting the arrival of a multipath signal. Fig.6.6/4 results from a multiple transmission which confirms a variable multipath component, presumed to be via the surface, which is modifying the envelope after the initial edge. Fig.6.6/5 is a single transmission taken with the array tilted down 2 degrees. The reverberation from the lake bed has increased significantly. The vertical beam width of the full Mk.2. array is better than 4 degrees, so at 300 metres range in 18 metres of water with the array untilted the beamwidth just ensonifies the full water column, i.e. cylindrical spreading is assumed from about 260 metres.

Fig.6.6/2.

Reference Target
-18 dB Sphere
Deployed at 300 metres.
single 5 ms transmission.
Array horizontal.

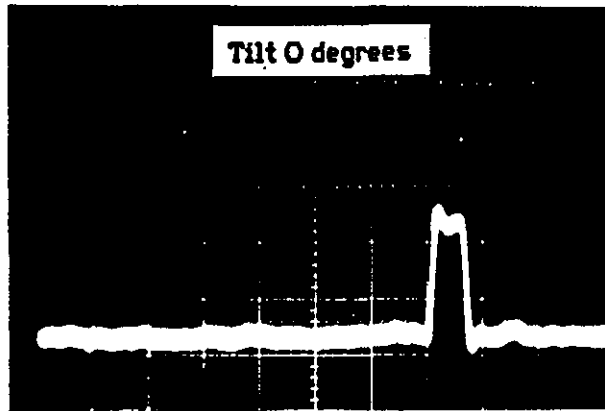

Fig.6.6/3.

-18 dB Reference target
at 300 metres.
Multiple transmission.
Array horizontal.

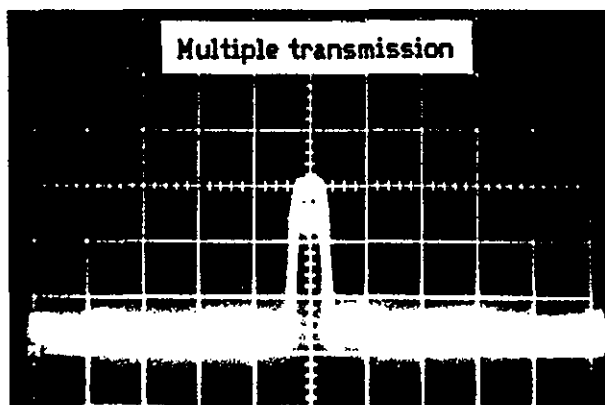
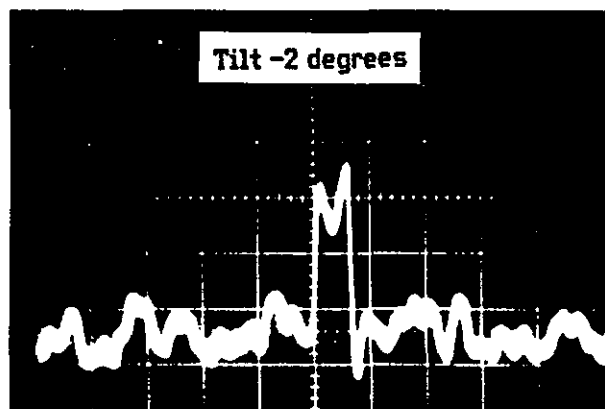

Fig.6.6/4.

-18 dB reference target
at 300 metres.
Single 5 ms transmission.
Array tilted down 2 degrees.



A MULTI-MODE TRANSMITTER

Chapter 7 CONCLUSIONS & DISCUSSION.

7.0 Objectives and Conclusions.

The study was initiated with the aim of demonstrating that microprocessor and digital logic techniques could increase the flexibility and effectiveness of a sonar transmitter. In the simplest practical sonar transmitter, i.e. the dedicated single frequency echosounder, the economic advantages of introducing digital synthesis are marginal. However for applications where greater waveform precision or frequency changes are envisaged the use of a microprocessor permits a single hardware circuit design to be tailored by software to suit changing applications.

The investigation of the phased array concept applied to a sonar transmitter has led to the successful development of reliable hardware and appropriate software for signal synthesis and control.

The associated development of high power MOSFET transistor linear amplifiers suitable for sonar applications has resulted in a commercially available 1 kW linear amplifier which meets most of the foreseeable requirements in the frequency band from a few hundred hertz to 100 kHz.

The transducer requirements for wideband high power operation in a staved phased array entailed investigation of suitable elements and resulted in a customised Tonpiltz 40kHz design. The manufacturer regards this element as a commercially important development and now offers it for a variety of demanding high power/wide band applications.

The microprocessor controlled multi-channel synthesis of signal data has been demonstrated to be a powerful tool generating a very wide range of signal types for projection into the water by the phased array. A variety of transmission modes have been tested and all of the original concepts have been successfully demonstrated, i.e. 'within pulse' sweeps, 'ripplefire' and electronically steered 'pings'. Additional concepts of focussing and sidelobe shading, Dolph-Chebyshev, have also been tested and the measured signal parameters in the water have matched the theoretical predictions in almost all of the experiments. The beam forming and steering characteristics established using the Mk.2 array have been remarkable close to theory.

7.1 The Advantages of a Multi-Mode System.

Phased array transmitter techniques have been demonstrated to give a variety of advantages. The apparent complexity and cost of a multichannel system is an economic disincentive but outweighed by the resulting increased operational facilities:

The inertia free steering of the beam direction is clearly superior to mechanical steering techniques where rapid steered response or swept sector characteristics are required.

The high directivity ensures that all targets are insonified efficiently with the maximum possible intensity as the beam is steered across the sector.

This mode of insonification also ensures optimum target detection in conditions of high reverberation i.e. in shallow water or under ice, particularly when synchronised with a matched scanning receiver.

Transmissions from a multichannel system incorporate a 'fail soft' characteristic and single channel failures are rarely catastrophic in effect. The system has proved to be reliable in use and has been operated in environmental extremes i.e. with air temperatures below freezing and above 33 Celcius.

The use of a number of small power amplifiers to drive individual staves of the transducer array enables ideal channel amplitude matching to be achieved, resulting in optimised transmitted beam patterns. Very even insonification of a swept sector can be achieved with less energy wasted in sidelobes outside the designated sector.

The technique of precomputing and storing the waveform for transmission can be applied over a very wide range of frequencies by optimising the sampling clock rate. The maximum practical frequency that can be generated depends on appropriate D/A conversion techniques and requires fast RAM memory devices in the data buffers. The existing signal synthesis hardware can generate sinusoidal signals to over 200 kHz with very minor circuit changes. For more dedicated applications, especially if fast bi-polar PROMs are used as buffers, signal synthesis for phased array applications could be extended to over 1 MHz.

The multi-mode transmitter in its present form has been developed as a research tool for generating precise signal waveforms at high source levels in the water which can be steered as required to interrogate a target. It is anticipated that this will prove to be a useful tool for studies of acoustic propagation. Used for target evaluation the flexible modes of operation

should assist classification studies. The equipment has not been configured for mobile operation and clearly to operate at full power without cavitation implies that the array will be deployed at some reasonable depth. If the system is required to be hull mounted on a surface vessel the maximum power will be restricted as approximately 20 metres of static water pressure is needed to avoid cavitation effects at full power.

7.2 General Discussion.

The multi-mode transmitter project has demonstrated the feasibility of applying micro-processor controlled signal synthesis to a phased array sonar. The component parts of the system are reproduceable and two complete systems, the 2kW Mk.1 and the 16kW Mk.2, were constructed. The system design has been influenced by the investigative requirement and the result is primarily the intended flexible research tool. However, many of the individual modes could now be exploited in isolation using simpler control circuitry and with signal synthesis data fixed in PROM memory.

The multi-mode transmitter is a complete self contained transmission system and the support software permits signal synthesis modifications to be made in a trials environment if necessary, without requiring separate computer facilities. Software can also be developed conveniently off-line using a similar microcomputer without access to the transmitter hardware and data and control files transferred by floppy disk. The Mk.1 low power system is retained as a test facility for use both in the University's tank at Loughborough and at Foremark reservoir for testing newly developed software. The Mk.2. 16 kilowatt version is now based at the ARE(LG) acoustic range, where the long deep water paths available permit the investigation of low frequency non-linear parametric signals. The next phase of this work is planned to exploit non-linear acoustic effects and to develop suitable matching receiver techniques. The original expectations of flexible operation have been implemented successfully and new applications continue to evolve. To expand the system beyond its present capability, specifically if long complex waveforms are to be synthesised, will require some significant hardware modifications. The use of the compact 256 sample data blocks, when linked to the 16 adjoining blocks, limits the maximum pulse length for unique data to approximately 8 milliseconds at the 500 kHz clock rate. Using a slower clock rate can increase this pulse length but at the expense of the waveform

resolution. However as the waveform amplitude is defined by only 4 bits this resolution is already marginal for some applications. Direct synthesis in real time of each channel's data could eliminate this problem and given the steady improvement in speed and computing power of each new generation of microprocessors it is anticipated that practical systems using DSP devices and RISC architectures will make this possible. An interim solution which improves the existing multi-mode transmitter has been designed which increases the size of the memory buffers. This uses 8 bit resolution to define the waveform amplitude and can exploit much longer buffer lengths. This solution has the side effect of dramatically slowing the data loading time and the data files will need to be held on a hard disk to minimise the loading time penalties. A single 8 bit version of an enlarged buffer memory has already been built which increases the channel data capacity from 32 x 4 bits to 64 kbytes and the initial tests with this prototype card driving all the amplifiers in parallel was successfully used to generate a sequence of amplitude modulated 'raised cosine' pulses.

7.3 System Reliability.

The final version of the high power system has proved to be quite reliable, the only significant 'down time' was caused by a failure in the polyurethane sheathing of both transducer umbilical cables. This resulted in the cables flooding with seawater and the immediate loss of one channel which shorted out. The cable capacitance of the remaining wires increased dramatically which in turn caused some overload to the power amplifiers but fortunately no failures. This unexpected problem was apparently caused by fatigue failures in the outer polyurethane jacket of the cables after the array had been deployed in the sea for several months at 30 metres depth. A consultants report on the cable failure indicated a manufacturing defect possibly aggravated by the high static pressures involved¹. The heavy duty pan and tilt training gear suffered a similar sheath failure, fortunately the low voltages involved have enabled this unit to continue to function but the cable and penetrator need replacing. The training gear tilt axis flange/shaft mounting was found to work loose causing some undesirable backlash after a few days operational use. The design of the flange fixing was apparently at fault and simple retightening together with the application of screw locking compounds did not provide a long term cure. A position indicating potentiometer also

failed within this unit and to cure both problems quickly required the pan and tilt head to be returned for a short period to the manufacturer. Apart from some early computer interface problems, which required modifications to the stepper motor control circuits, the pan and tilt assembly has proved to be reliable. The integration of the precision training gear with a microcomputer has produced a beam plotting facility that has been most valuable in assessing the performance of the multi-mode transmitter. A second version of this computer controlled beam plotter has now replaced an earlier analogue system for most transducer beam plotting applications at Loughborough.

7.4 Improving Hydrophone Data Acquisition.

The recovery of hydrophone signals for analysis purposes has, for most trials, been achieved with direct cabling. The source level experiments in Foremark reservoir pointed out the problems of attempting direct measurement using equipment in a small boat. Recording signals for later analysis requires a wide band instrumentation recorder and although the Nagra IV-S recorder has been useful in acquiring low frequency signals a much wider band instrument is needed to satisfactorily record the carrier second harmonic at 80 kHz. The available Ampex FR1300 recorder is unsuitable for such mobile experiments and it is now recognised that feedback to the transmitting point is essential if the transmitted signals are to be optimised on the hydrophone position. The anticipated work in Lochgoil will require measurements made at significantly increased ranges and whilst the Maytime research facility has demonstrated the capability of hydrophone cable runs deployed along the surface to ranges greater than 500 metres this technique has clear limitations. An investigation of broadband data radio telemetry has led to the construction of an experimental microwave system operating in the 1.3 GHz amateur band. This battery powered equipment offers the capability of a broadband 6 MHz FM 'video' link plus an optional auxiliary FM voice channel, both with excellent signal/noise ratio. Operating at low power (4 watts RF) this has been tested over water to 4 kilometers and should function over much greater 'line of sight' ranges without problems. For the initial tests the received signals were fed directly into a 100 kHz spectrum analyser with very satisfactory results. Encoding the hydrophone signals digitally prior to transmission is envisaged as the best technique for the future as the telemetry bandwidth could accommodate 16 bit encoding at data rates suitable for signals containing

significant components up to 100 kHz. The study of the non-linear signal distortion, and the propagation characteristics of the parametric products resulting from high power modulated transmissions will require a series of measurements at increasing ranges. The near-field of such virtual end-fire arrays may extend for several hundred metres and the radio telemetry approach should provide consistent measuring characteristics, regardless of range.

7.5 Future Developments.

The flexibility of the multi-mode concept should ensure that it will remain a useful research tool for testing custom designed signals which can be synthesised quickly and projected for evaluation.

In considering future applications the use of the system as a parametric source of low frequency sound with high directivity appears very likely. In the context of parametric transmissions it has already been noted that at long ranges a very high source level can be achieved at 80 kHz, generated as the non-linear distortion of the signal enhances the second harmonic of the transmission frequency. The signal is sustained while within the length of the NLA virtual endfire array and this 'pump' effect partially offsets the normal absorption loss. Further experiments are planned but the effect has obvious uses especially if rippled or swept across a sector which is synchronously scanned by a more conventional 'within pulse' modulation scan receiver.

The multi-mode transmissions permit both rapid interrogation of a sector or the selection of a specific single bearings. Data for several types of transmission with differing characteristics can also be stacked for instant access. The flexibility gained by these techniques should be especially advantageous for target detection and classification applications.

Applications of the Multi-Mode Transmitter to fisheries research need to be explored. Sonar estimates of fish shoal 'bio-mass' are traditionally based on echo-sounding sections made through a selected fish shoal using a single channel precision beam echosounder with precision signal processing to assess the target strengths of resolved individual fish. This effect is particularly pronounced in the case of fish with swim bladders which rarely approximate spherical shapes and hence have significant directivity which varies with swim attitude. High sonar frequencies are necessary for multi-target discrimination but an argument can also be made for the use of much

lower sonar frequencies where the target directivity becomes less variable. The use of a non-linear transmission may conceivably permit both the low and high frequency characteristics of such bio-mass to be assessed simultaneously. A multi-beam or swept transmission could sample a much greater volume of the shoal and thus increase the data acquisition rate.

Extending phased array steering into both azimuth and elevation planes opens the way towards stabilised beam forming and three dimensional scanning. Such a system would require increased channel complexity but the techniques required to implement it can be seen to be practical. The existing Mk.2 array was configured to allow access to the vertical axis in substaves of 4 elements. If phase steering techniques are applied to the vertical axis it can be seen that steering is limited to a maximum angle of 7 degrees (4λ pitch) before the grating lobes create ambiguities. This limited beam shifting might prove useful as a correction factor for vehicle orientation instabilities, especially if the array is to be installed on an ROV or as part of deep towed assembly.

Chirp or coded pulse transmissions improve target detection thresholds very significantly if suitable matched pulse compression or correlation reception techniques are used in the receiver. The multi-mode transmitter simplifies the synthesis of such signals and provides a suitable test facility for the exploration of such signal processing techniques when used with steered signals.

The ability of the multi-mode transmitter to steer signals rapidly into adjoining parts of a sector by ripple fire or sweep techniques is demonstrably an efficient insonification technique. However the echoes returning from these adjacent bearing require some method of bearing discrimination. The use of a 'within pulse' sector scan receiver, locked to these transmissions is clearly an optimum solution although the most complex and expensive. The wide bandwidth of the Mk.2 transducer (11 kHz) opens the way to bearing coding of the transmissions. The simplest option being a discrete frequency transmission for each bearing. Decorrelating the bearing information from the echoes becomes simply a matter of spectral analysis but this needs to be accomplished in real time. Fast Fourier Transforms can be used to analyse a signal for its frequency components and software routines to implement FFT's on the new generation of Digital Signal Processing ic's e.g. MC56000, TMS320c25 or the Inmos Transputer need to be investigated. The

speed of such routines will define the achievable range resolution. Simple parallel analogue or digital filtering techniques are practical and will not suffer the same speed restrictions. An analogue receiver based on this concept is planned. Exploiting non-linear signals, where a low frequency 'parametric' product is developed in the water, offers even greater bandwidth possibilities although the efficiency is low as is the achievable source level. In addition to very wide band performance such NLA transmissions have the unique advantage of very high directivity without sidelobes. This property of sharply defining the beam width of a low frequency signal has clear advantages in highly reverberant conditions. If the low frequency products exhibit similar directivity to the 'pump' primary, can be steered and can be encoded easily, then a low frequency long range transmitter scanning sonar may become a practical possibility. In the absence of bearing encoded transmissions the reception of such low frequency signals will require a very large receiving aperture to discriminate target bearing angles. Bearing coded transmissions at both primary (carrier) frequencies and at NLA secondary (parametric) frequencies are therefore seen as the key to an integrated transmitter scanned sonar 'Transcan' concept.

It is hoped that the techniques described in this study indicate practical alternative approaches to some of the problems of sonar signal generation.

A MULTI MODE SONAR TRANSMITTER

REFERENCES

Chapter 1

- 1.0 Voglis and Cook. 1966.
'Underwater applications of an advanced acoustic scanning system.'
Ultrasonics, (4).
- 2.0 Duck, Goodson and Griffiths. 1984.
'Seavision - A New Sector Scanning Sonar.'
Proc: IEE Colloquium (London). 'Underwater Navigation'. c3.p1-4.
- 3.0 Skolnik. 1962.
'Introduction to Radar Systems'
Pub: Macgraw Hill. 2nd Ed. 8:278-342.
- 4.0 Janes Weapons Systems. 1987.
'Marine Radar' (UK) (USA) etc.
Pub: Janes Pub.Inc. N.York.
- 5.1 Goodson, Griffiths, Gida and Cook. 1987.
'A High Power Flexible Sonar Transmitter'
Proc: Conf. IERE (Edinburgh), v72.:101-112.
- 6.2 Pratt. 1978.
'High Power Transmitters For Sector Scanning Sonar Systems'.
Proc: Conf. I.o.Acoust. (Lowestoft).
- 7.2 Vyas 1980
'High Definition Deep Sea Sonar'
Int.Rep: LUTEE / IIT (Delhi) Phase II.
- 8.2 Bi-polar Sonar Transmitters of this family, designed and built
at Loughborough University, were supplied to:
ARE(T), MAFF, DAFS, The Rijkswaterstaat, in Holland, and the
Belgian Hydrographic Service.
Most of these transmitters are still part of operational equipment.
- 9.3 Goodson, Griffiths, Wood and Cook. 1986
'A Flexible Sonar Transmitter'.
Proc: I.o.Acoust. (Salford), v8.3.p197-206.

- 10.3 Cook, Goodson and Griffiths. 1988.
 'A Low Frequency Sector Scanner Using NLA.'
 in: 'Underwater Data Processing', Ed: Chan. Pub: Kluwer, p47-53.
- 11.3 Cook, Goodson and Griffiths. 1989.
 'A Sector Scanning Sonar Using Transmitter Scanning.'
 Proc: Under Sea Defense Technology (London) p718-724.

Chapter 2

- 1.0 Skolnik 1982
 'An Introduction to Radar Systems'
 Pub: Mcgraw Hill. 2nd Ed. p280-282.
- 2.4 Kock 1973
 'Radar, Sonar and Holography an Introduction'
 Pub: Acad. Press London.
- 3.4 Warnes 1982
 'The use of anti-phased zones in an acoustic Fresnel Lens for a scanning sonar transmitter'
 Ultrasonics (7) 184-188.
- 4.5 Hansen 1986
 'Linear Arrays' p714-773.
 in: 'The Handbook of Antenna Design'
 Ed.s: Rudge, Milne, Olver and Knight.
 Pub: P.Perigrinus for IERE.
- 5.6 Rusby 1970.
 'Onset of Sound Wave Distortion and Cavitation
 in Water and Sea Water'. Pub: J.Sound Vib. 13(3),257-267
- 6.6 Clay and Medwin 1977.
 'The Cavitation limit' p170-175
 in: 'Acoustic Oceanography: Principles and Applications'.
 Pub: Wiley.
- 7.6 Clay and Medwin 1977.
 'The virtual endfire array' p162-170.
 in: 'Acoustic Oceanography: Principles and Applications'.
 Pub: Wiley.

- 8.6 Westervelt 1963.
'Parametric Acoustic Array'.
Pub: J.Acoust.Soc.Am. Vol.35 535-537.
- 9.6 Merklinger 1975.
'Improved Efficiency in the Parametric Transmitting Array.'
Pub: J. Acoust.Soc.Am. Vol.58.No.4.
- 10.7 Ross 1973.
'Coded Signal Design for a Transmitter Scanned Sonar'
Pub: Journ. Sound & Vib.29(2),p227-255.
- 11.7 Hill, Bahl, Carey-Smith et al. 1987.
'An I & Q Sonar Receiver
Using Digital Signal Processing Techniques.'
Int.Rep: LUTEE.

Chapter 3

- 1.1 Nascom II, Manual. 1980
Pub: Lucas Logic Ltd.
- 2.1 'The 80 bus standard' 1980
Pub: Gemini Microcomputers Ltd.
This is based on a (5U) 77 way edge connector and defines all the signals required for expansion of a Z80 microprocessor.
- 3.1 'CPM' is a trade mark of Digital Research Inc.
Control Program and Monitor is a disc based operating system designed to be implemented on 8080, 8085 and Z80 micro-processor systems. It creates a 'machine independent' system by routing its I/O communications through reconfigurable lookup tables.
- 4.2 BLS-PASCAL written by APS of Denmark
initially released as 'Blue label software' and later by Lucas Logic Ltd as NasPas.
- 5.2 Crimson Elektrik(Leicester) Ltd. Now based at Stoke on Trent.
- 6.2 LUTEE internal report 1986.
'The 100 watt Crimson MOSFET Power Amplifier for the Flexible Transmitter'.
- 7.3 Formerly Pantechnic now Tunewell Transformers Ltd.,
115a, Myddleton Road, Wood Green, London N22 4NG.

- 8.5 Decarpigny, Debuss, Hamonic, 1987.
Bossut, Tierce, Morrel, Boucher and Tocquet.
'Finite Element Analysis of Low Frequency Sonar Transducers'
Conf.Proc: I.o.A (Birmingham) v9.2 p42-51.
- 9.5 Wood et al. 1986.
'Investigation of the prototype 15 element array'. Int.Rep: LUTEE.
- 10.6 Wood et al. 1986.
'Wideband elements for the flexible transmitter'. Int.Rep.LUTEE.
- 11.7 Wood, Wood, Goodson & Griffiths 1987
'A High Power Transducer Array.'
Conf.Proc: I.o.Acoust.(Birmingham), v9(2)p88-100.
- 12.8 Gida 1988
'A Synthetic Aperture Sonar'. LUTEE PhD Thesis p223.

Chapter 4.

- 1.1 Jensen and Wirth 1975
Pascal User manual and Report.
Pub: Springer Verlag. N.Y. 2nd ed.
- 2.1 Marsh 1985
Pascdos Pub: Kenilworth Computers Ltd,
- 3.1 TurboPascal 4.0
Pub: Borland International,
4585 Scotts Valley Drive, Scotts Valley, California.U.S.A.

Chapter 5.

- 1.0 Hill 1986
'An Automatic Beam Plotting System'
Proc: I.o.Acoust (Salford) v8.3 p207-212.
- 2.4 Goodson et al. 1989.
'Subaqueous Terrain Modelling,
An aid to Scanned Sonar Interpretation.'
Symposium S.U.T. (Aberdeen).
Pub: J.Soc.for Underwater Technology. v15,(1) p22-24.
- 3.5 Gida 1988
Synthetic Aperture Sonar LUTEE PhD thesis.

- 4.6 Brown.P. PvDF Plate Hydrophones
Data sheet and calibration chart.
Central Research Laboratory, EMI Ltd., Hayes Middx.
- 5.6 LUTEE internal reports various (1986/7) evaluation of:
Plessey SL560 / 561 / 1612 etc.
- 6.8 L.S.I. Colour Sound Spectrograph supplied by:
Loughborough Sound Images Ltd.,
Epinal Way, Loughborough, Leicestershire LE11 0QE.

Chapter 7.

- 1.0 Hemsley . 1988
'Examination of Polyurethane Coating from Underwater Cables'
Loughborough Consultants Ltd. MP/ARE/752.
Consultants Report commissioned by ARE(T).

A MULTI-MODE SONAR TRANSMITTER

APPENDICES

- Appendix I - Drawings and Circuit Diagrams.**
- ii Bridge A - Address and Data Buffers, Port switched.
 - iii Bridge B - Programmable Read Address Generator.
 - iv 32 k x 4 bit - Channel Buffer Memory and D/A converters.
 - v 1 kW linear MOSFET amplifier including Hi-Slew Driver.
 - vi PCB mask for Channel Buffer D/A 'piggyback' card.
 - vii PCB mask for improved drive card for 1 kW amplifier.
 - viii Pre-release drawing of 256 element Mk.2.Array.
- Appendix II - LUTEE Beam Plotter.**
- i Computer controlled beam plotter hardware.
 - ii Beamplotting Software.
 - iii Sampling Electronics.
- Appendix III - Software, Control Program Listing.**
- ii Pascal listing of program - RIPPLE60.
 - v Pascal listing of program - STEERd.
 - xii Pascal listing of program - DISPLAYf.

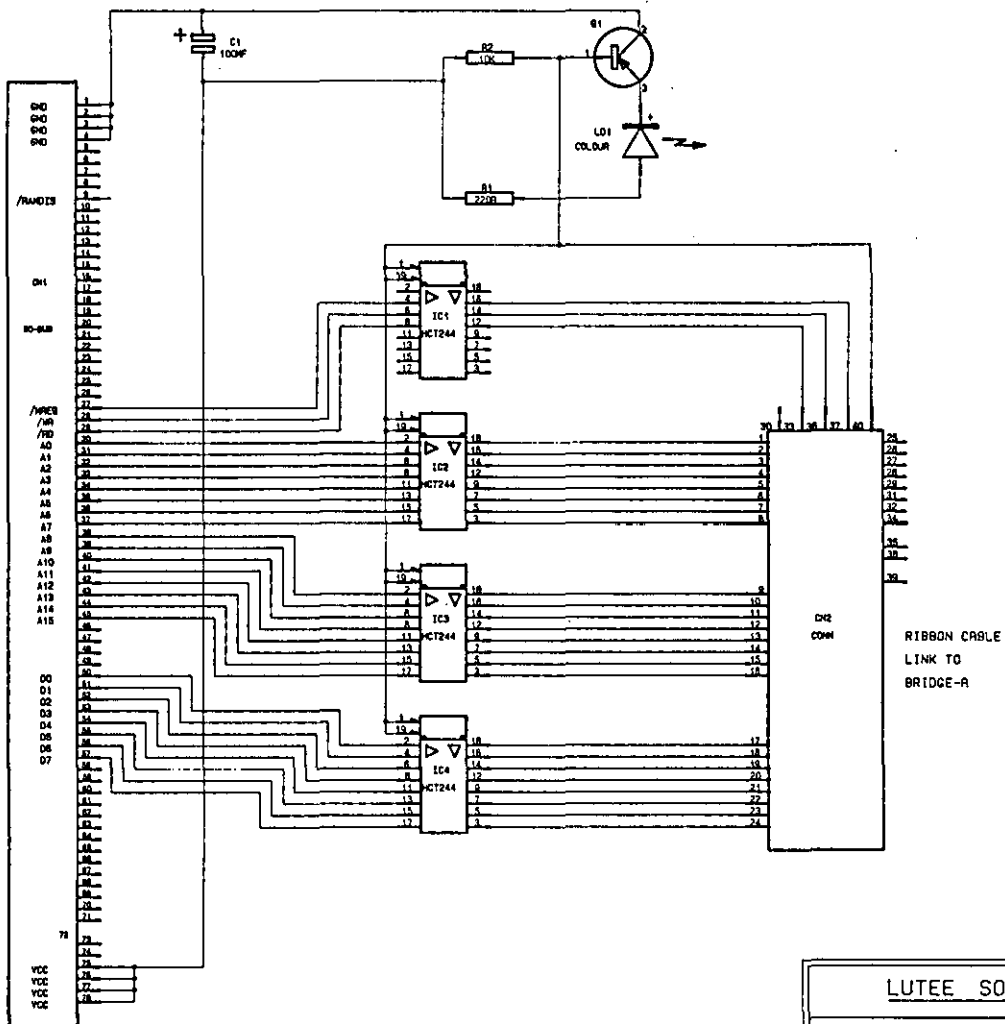

LUTEE SONAR & SIGNAL PROCESSING RESEARCH GROUP			
DRN. BY.	A. D. Goodson	PROJECT	MULTI-MODE
DATE	20/05/89	TITLE	SONAR TRANSMITTER
REF. NO.	FTX 10049ADC		80 BUS EXTN. CONTROL BRIDGE-A

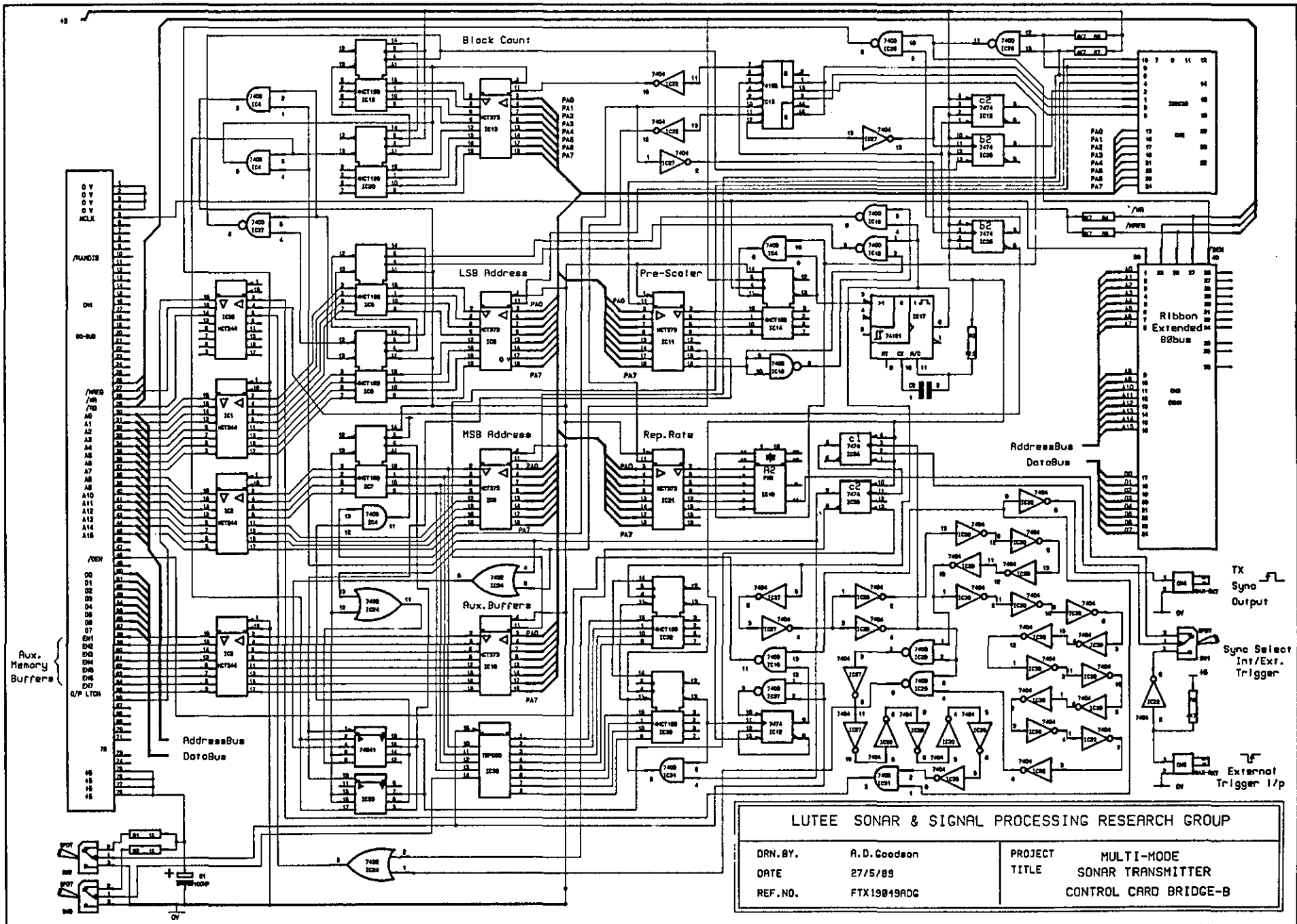

LUTEE SONAR & SIGNAL PROCESSING RESEARCH GROUP

DRN. BY.	A.D. Goodson	PROJECT	MULTI-MODE
DATE	27/5/89	TITLE	SONAR TRANSMITTER
REF. NO.	FTX19049ADC		CONTROL CARD BRIDGE-B

AI - I

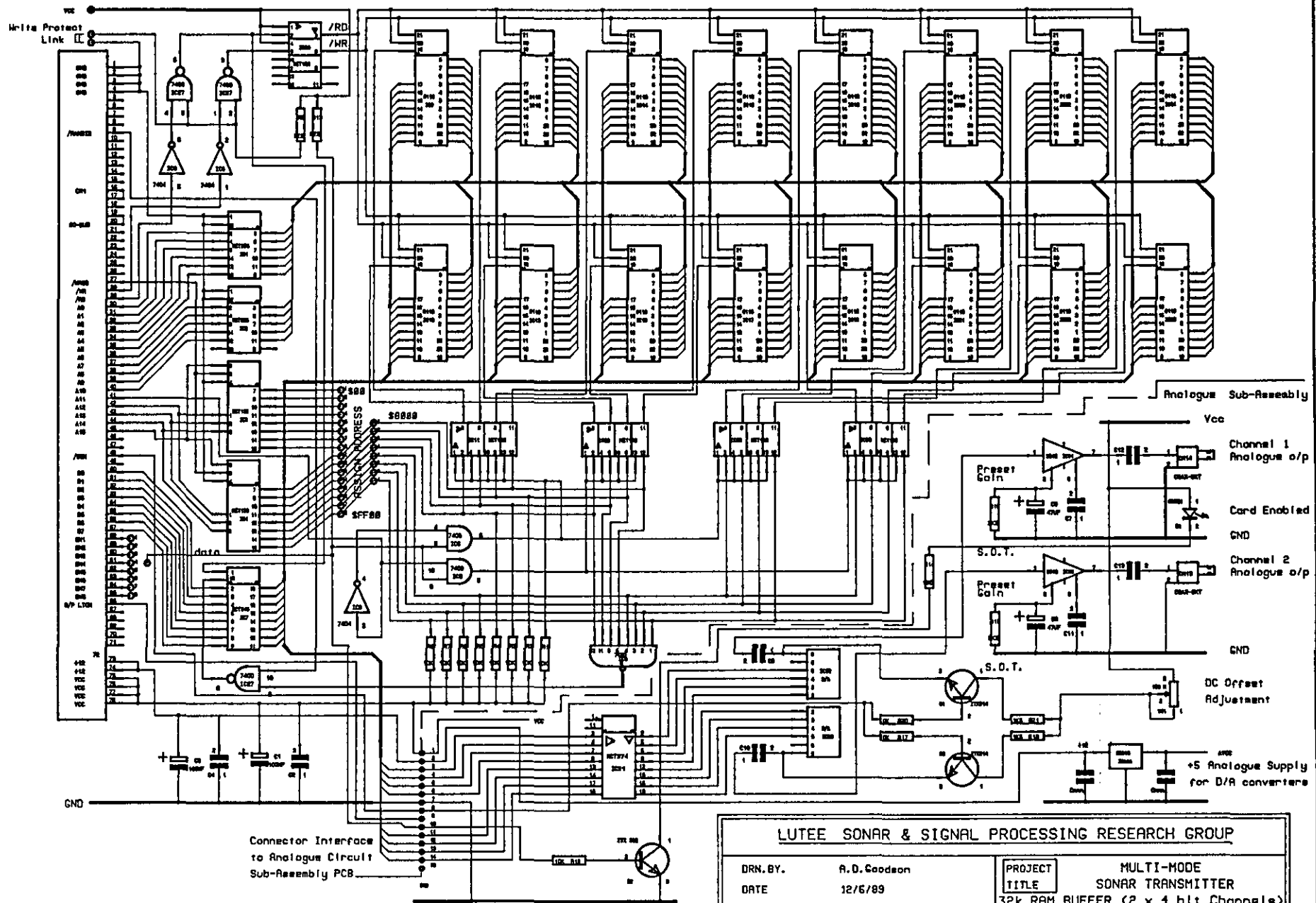

LUTEE SONAR & SIGNAL PROCESSING RESEARCH GROUP			
DRN. BY.	A. D. Goodson	PROJECT TITLE	MULTI-MODE SONAR TRANSMITTER
DATE	12/6/89	32k RAM BUFFER (2 x 4 bit Channels)	
REF. NO.	FTX 19049 adg	Version 2 (Based on Microcode Ltd. PCB)	

Connector Interface
to Analogue Circuit
Sub-Assembly PCB

Analogue Sub-Assembly

Vcc

Channel 1
Analogue o/p

Card Enabled

GND

S.O.T.

Channel 2
Analogue o/p

GND

DC Offset
Adjustment

+5 Analogue Supply
for D/A converters

A - I

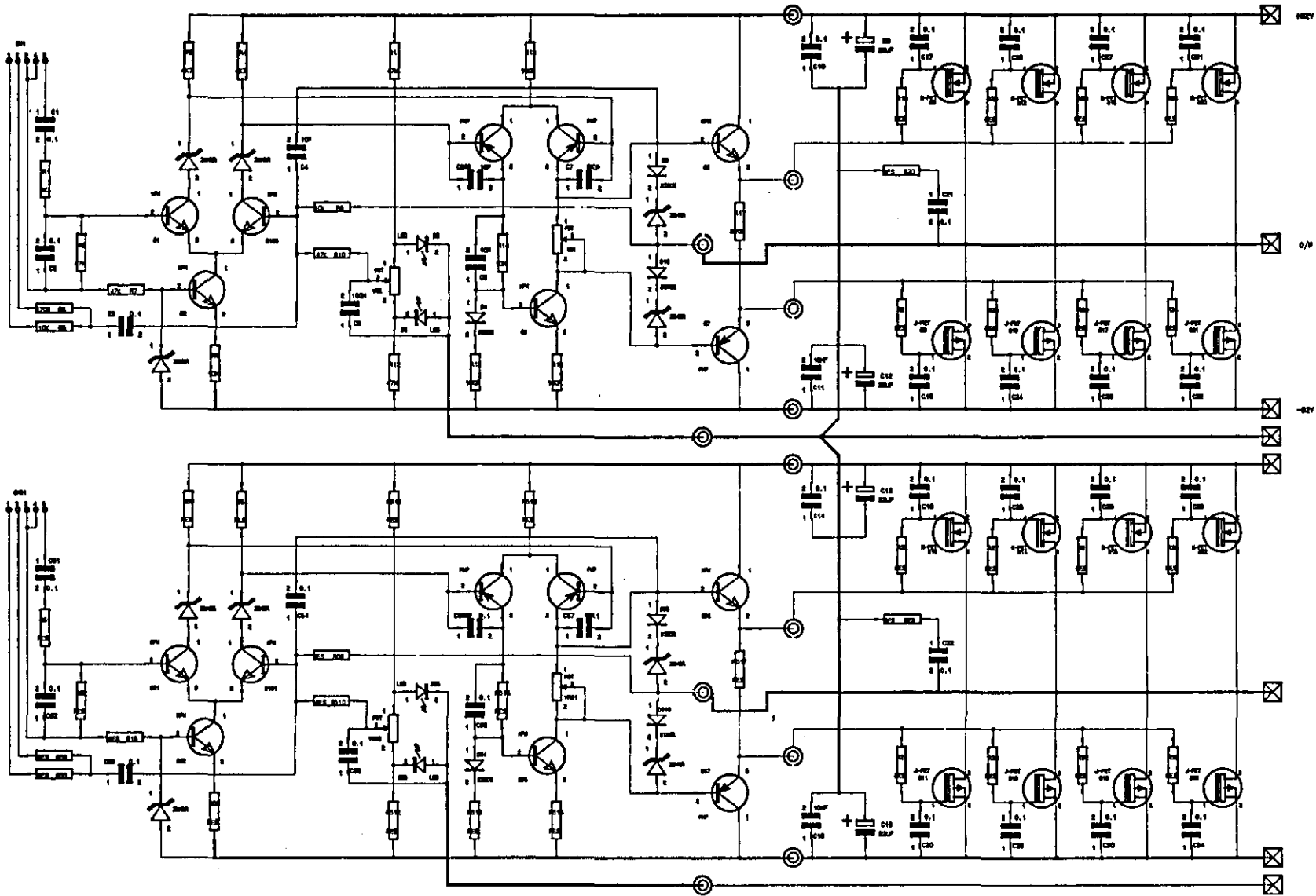

LUTEE SONAR & SIGNAL PROCESSING RESEARCH GROUP			
DRN. BY.	A. D. Goodson	PROJECT	MULTI-MODE
DATE	10/7/89	TITLE	SONAR TRANSMITTER
REF. NO.	FTX 87879 adg		1 KW MOSFET POWER AMPLIFIER

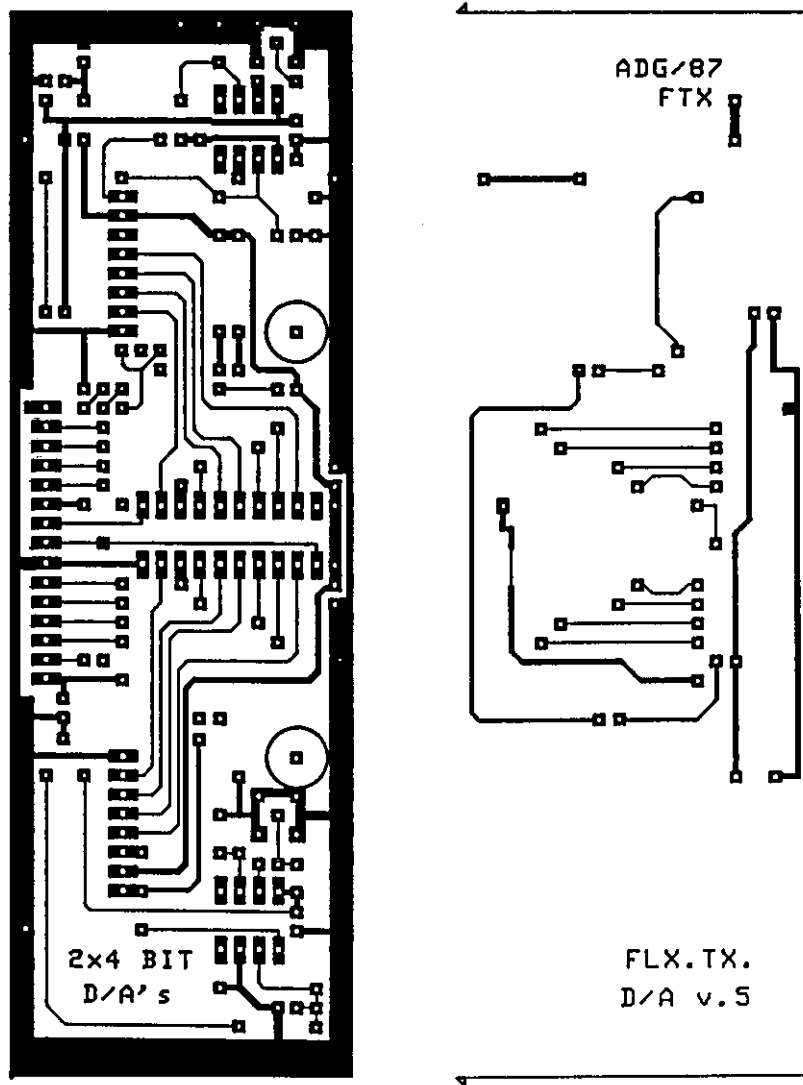

Printed Circuit Mask for the 'piggyback' board required to be mounted on each channel buffer memory.

The card provides direct access to the internal memory data bus and latches 8 bit samples on command for conversion via two 4 bit D/A converters. The analogue signals are low pass filtered and accessed via two Suhner miniature coaxial connectors on the card front edge.

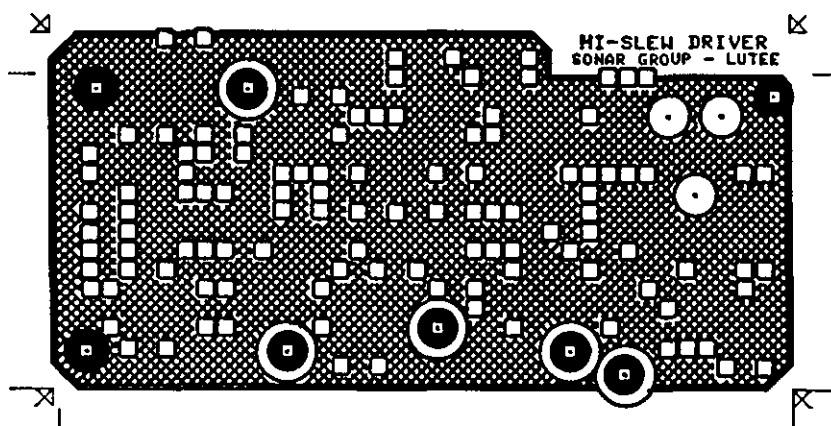
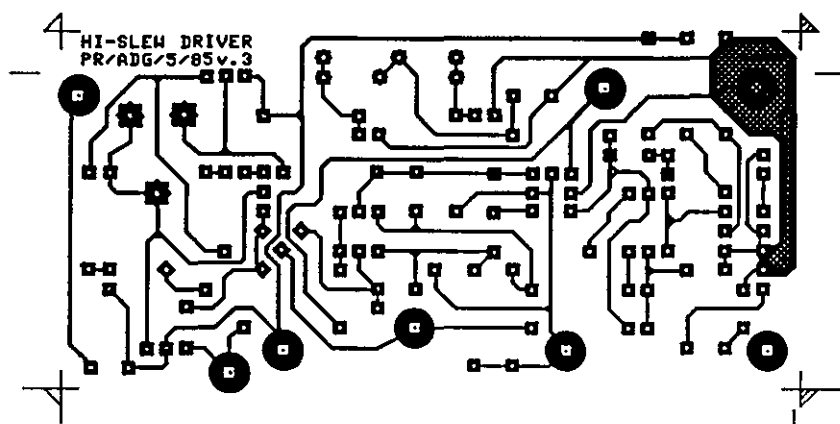

Printed Circuit Mask for the improved High Slew version of the drive circuit used in the 1 kW MOSFET amplifier. Each amplifiers uses two of these mounted above the MOSFET block on socket pins. The drive cards are identical with one configured for high gain i/p and other as a low gain inverter buffer. The track link between pin 2 and 3 needs to be broken to insert an optional external gain control potentiometer

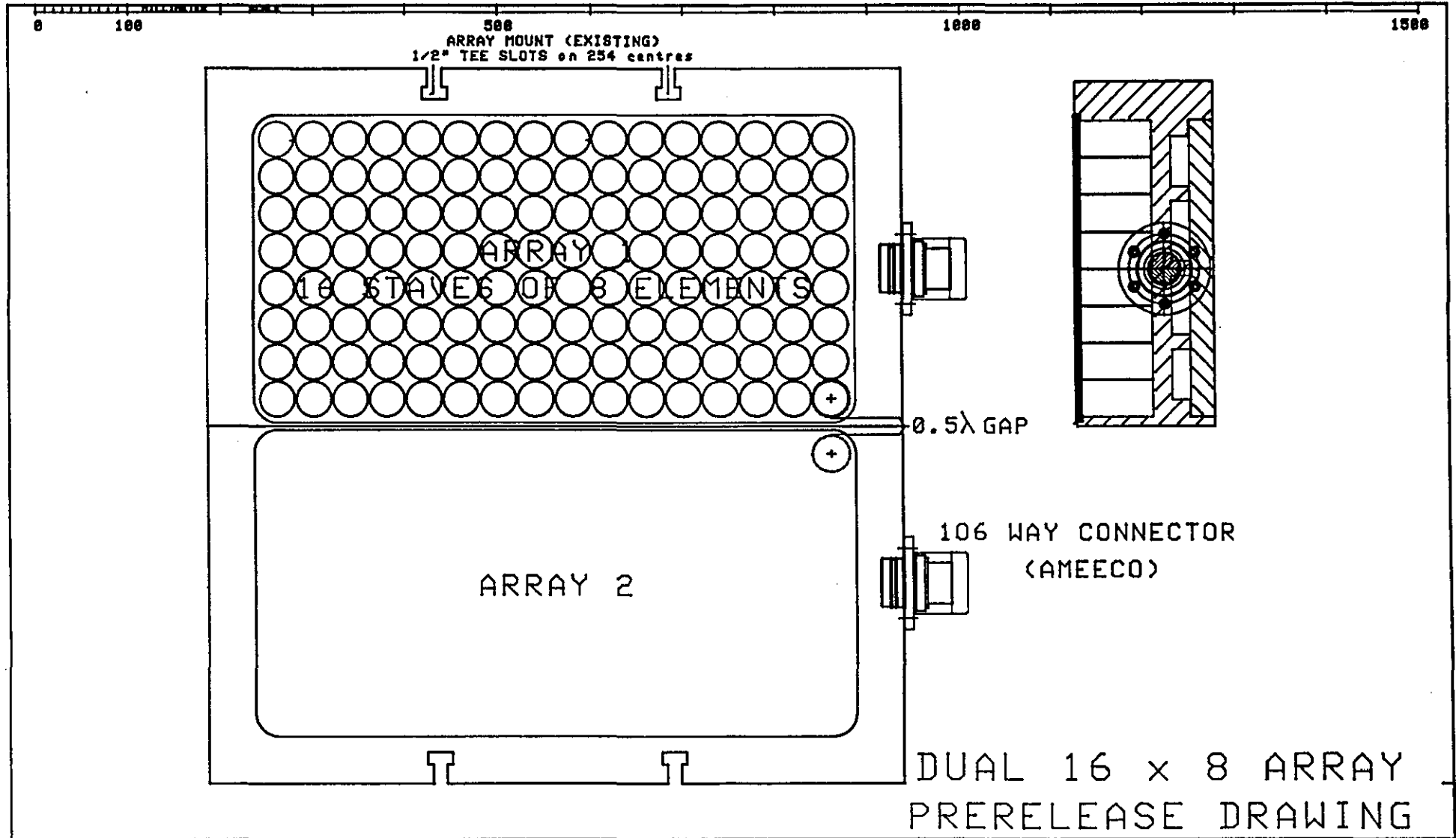

SONAR RESEARCH GROUP
LOUGHBOROUGH UNIVERSITY

FLEXIBLE SONAR
TRANSMITTER

DRG. NO: ADG84-1-1

DATE: 19-1-85

APPENDIX II LUTEE Beam Plotter

1	Pan and Tilt Hardware.	.	.	i.
2	Control Software.	.	.	ii.
3	Sampling Electronics.	.	.	iii

1 The LUT beam plotting hardware.

The LUTEE system devised for precision beam plotting utilises a remotely controlled, stepper motor driven, waterproof training gear with azimuth and elevation axis. Two versions of which have been acquired from the manufacturer, Molyntx Ltd. The first type is constructed using a cast aluminium waterproof housing and this is used in both fresh and salt water. Some corrosion problems occurred, aggravated by surface damage, which necessitated overhaul but the units have functioned reliably for some considerable some time. The more powerful unit commissioned primarily for this project is shown in chapter 3 Fig.3.7/1 supporting the Mk.2 array during deployment at Foremark. This second type is constructed from stainless steel and has a rated operating depth in excess of 500 metres. Functionally the underwater units differ only in their final gear box drive ratio. An internal view of the housing and gearbox is shown below.

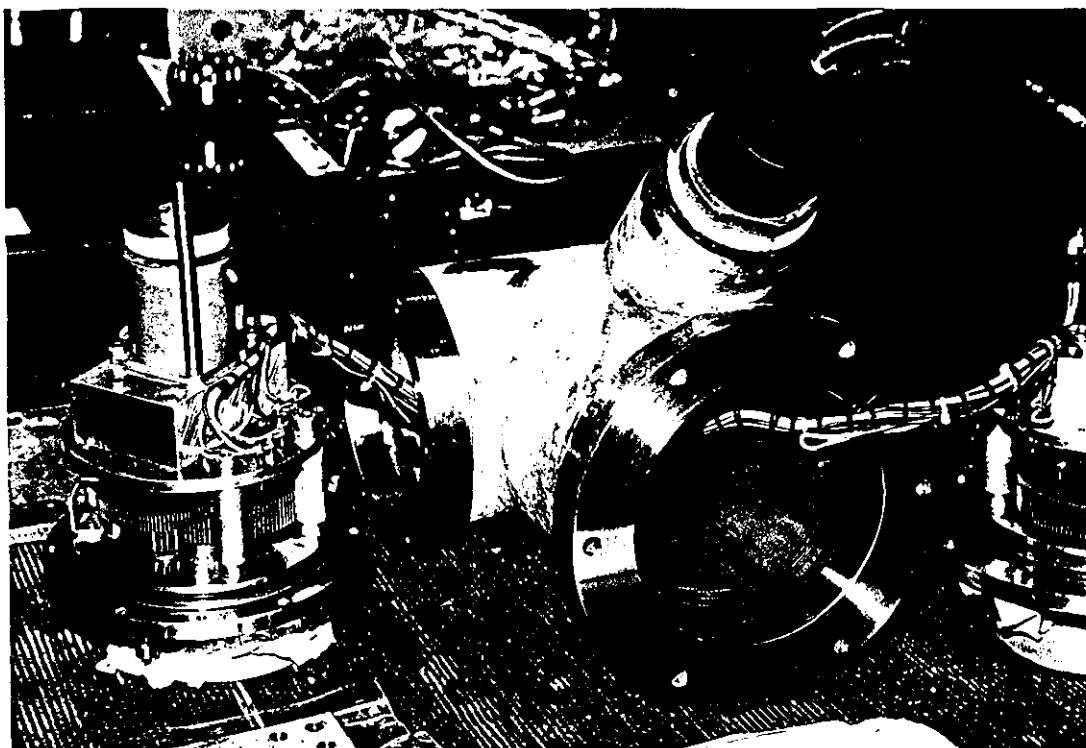

The devices can be controlled manually by joystick or by axis push-buttons or the controls can be interfaced to a microcomputer for programmed motions. In practice, while beam plotting, only the horizontal panning axis is driven by the computer. The synchronous acquisition of the signals received by the remote hydrophone has to be arranged by additional sampling electronics controlled by the same program and taking its delayed timing from the transmitter trigger pulse.

2 Beamplotting Software.

The control software for plotting is menu driven and permits the selection of a sector angle to be panned through and the increment size between each sample point. Additionally the zero position can be set after manually determining the best position. The program starts by rapidly offsetting the array position to half the required sector angle and then with predetermined delays for sampling steps through the whole sector whilst recording 10 bit data samples at each step. On completion of the scan the array is rapidly panned back to the centre zero position. Simultaneous with the action of sampling the data a screen plot graphing the amplitude received versus the angular position is displayed. This data can be subsequently labeled and stored onto a floppy disk and a hard copy plot can be generated on either a printer or plotter. When redisplaying the data either linear or log plots options can be selected.

The control software has evolved in several generations. The first version, written very quickly for the initial Staines reservoir trial, contained a subtle bug which incrementally produced a zero offset after each plot. The data files recording these plots are therefore difficult to relate to precise steered angles. At the time additional accuracy checks were made using the mechanical azimuth scales on the array support and these gave good confidence that the phase steering modes were consistent and correlatable.

Later versions of this software were used successfully with both pan and tilt systems and only very recently has a re-written version taken over. It was noted during a laboratory test of the Mk.2 heavy duty pan and tilt, using a laser, that an error in scaling of .08% existed in the positioning accuracy. This problem existed as the software, written in BBC assembler code used integer arithmetic and the low ratio gear box in this second unit included a non-integer division factor. Additionally the original disk storage technique

retained only the plotted screen positions and not the actual amplitude data. This technique seriously limited the re-displayed dynamic range when a logarithmic plot was required and introduced an undesirable artificial quantisation noise floor below 45 dB. A re-written program in Basic has eliminated both problems although fewer data files can now be stored on a single floppy disk. Only the stepper motor control signals have been retained in assembler language for efficiency and these routines were changed to assist the equipment to decelerate as it approaches each sampling point.

3 Sampling Electronics.

The analogue data acquisition required additional circuitry before the digital samples can be obtained. The interface box between the sampling hydrophone and the computer contains adjustable gating delays triggered from the sonar transmitter. These delays permit an variable width range gate to be applied to the hydrophone signal and are essential if multipath signals are to be ignored during the plot. The analogue sample, triggered by the range gate delay logic, feeds a peak detector and this outputs a a latched DC level between samples derived from the signal amplitude. The output of this peak detector is fed to a A/D converter within the microcomputer (BBC plus). One significant modification is needed in the BBC microcomputer to take full advantage of this system, this involves replacing the internal A/D converter's reference voltage with one of greater precision. The simple reference used as standard is vulnerable to power rail noise and it is not normally possible to achieve the full 10 bit accuracy without a circuit change. The modification involves a pre-regulator applied to the 12 volt rail to generate a quiet 5 volt source. This is then used with a 'bandgap' precision reference to supply the A/D converter with an effectively noise free voltage for comparison. The result works well and the full 10 bit resolution can be achieved.

APPENDIX III Program Listings.

III-ii	Pascal Listing - RIPPLE60
III-v	Pascal Listing - STEERd
III-xii	Pascal Listing - DISPLAYf.

```

Program RIPPLE60;
( Computes data for 60 degree sector ripple )
( Writes set of unmodulated files: mcXS0m60 )
( Last update ADG 15/6/87 )
( Calculates focussed and steered data one bearing at a time.)
( Assumes Hardware Modification to clamp O/P. SET77 removed. )

```

```

label REENTER1;
var NBbegin,NBend,SAMPLE,X,I      :integer;
    BLOCK,BLKS,CHANNEL,YBYTE     :integer;
    Bd,L,H,J,K,Z,ADDR            :integer;
    CYCLES,FREQ,LAMBDA,FI,F,D,OMEGA :real;
    Focus,PhaseSTR,A,B           :real;
    Y                             :ARRAY[0..256]of integer;
    B,Q                            :string[11];
    File                          :String[8];
    S                             :String[255];
    S1                            :String[11];
    Eof,Bad,Pleasedelay          :Boolean;
    RE                             :Real;
    I,Sectorcount,Loop           :Integer;

```

```

Function ItoS(I:Integer):String[6];External #C051;
Function StoI(S:String[6]):Integer;External #C054;
Function RtoS(R:Real;L,P:Integer):String[60];External #C057;
Function StoR(S:String[60]):Real;External #C05A;

```

```

procedure CLS;
  CODE #3E,#0C,#F7;

```

```

procedure PAUSE;
  var k:integer;
  begin REPEAT k:=keyboard UNTIL k<>0;end;

```

```

procedure CLMEM;
  begin
  for I:=0 to #800 do
    mem[#8000+I]:=#77
  end;

```

```

procedure DECHEX;
  begin
  case NBbegin of
  1:B:='1';
  2:B:='2';
  3:B:='3';
  4:B:='4';
  5:B:='5';
  6:B:='6';
  7:B:='7';
  8:B:='8';
  9:B:='9';
  10:B:='A';
  11:B:='B';
  12:B:='C';
  13:B:='D';
  14:B:='E';
  15:B:='F';
  end;
end;

```

```

procedure BYTE;
  begin
  YBYTE:=round(X+16*Y[SAMPLE]);
  Y[SAMPLE]:=0;
  ADDR:= #8000+SAMPLE+(CHANNEL-2)*128+((BLOCK-NBbegin)*2048);
  mem[ADDR]:=YBYTE;
  (writeLn(ADDR,' ',YBYTE,' ',SAMPLE);)
  end;

```

```

procedure ELEMENT;
begin for SAMPLE:=0 to 256 do
begin
X:=round(7*sin(OMEGA*SAMPLE-Focus+PhaseSTR))+7;
if odd(CHANNEL) then Y[SAMPLE]:=X
else BYTE;
end;
end;

procedure DIRECTION;
begin
for CHANNEL:=1 to 16 do
begin
screen(10,13);
write('Calculating Channel No.=',CHANNEL:2);
writeln;
Focus:=(Pi*sqr(CHANNEL-8))/D;
PhaseSTR:=(BLOCK-8)*(CHANNEL-8)*Pi/7; (Pi/7 =4 deg.)
ELEMENT; (Pi/14=2 deg.)
end; (Pi/28=1 deg.)
end;

(procedure SET77; * Originally used to avoid hardware hangup.*
begin
for I:=0 to 8 do
mem[8000+I*100]:=77;
end; )

procedure PARAM;
begin H:=8000;I:=100;end;

procedure CHAR;
begin I:= 160-2; (160 to 145) write(chr(I));end;

procedure HI;
begin Z:=mem[H+((J)*100)+K-1] MOD 16;end;

procedure LO;
begin Z:=trunc(mem[H+((J)*100)+K-1]/16) end;

procedure PLOT;
begin
Bd:=0;CLS;
screen(1,16);
for J:=0 to 7 do begin
for L:=1 to 2 do begin
Bd:=Bd+1; screen(1,0);
for K:=1 to 28 do
begin if odd(L) then LO else HI; CHAR;end;
screen(21,0);write(Bd:2);screen(24,0);
(1/2 Block) (Full block)
for K:=(107 to 127 do) 235 to 255 do
begin if odd(L) then LO else HI;CHAR;end;
screen(1,Bd);
end;end;end;

(procedure DISPLAYm; * Used to display start and end phases *
begin
CLS;PARAM;PLOT;PAUSE
end;)

procedure Savemc(Var Bad:Boolean;S,F,E:Integer;F:String(8));External C04E;

procedure AUTOFILE;
var FN:string(6); Fo:string(2); FNAME:string(8);
begin
FN:=B; (ItoS(B));
Fo:=RtoS(F,2,0);
FNAME:=concat('mc',FN,'S0m60');
write(FNAME);
Savemc(Bad,8000,8800,0,FNAME);
screen(15,30);
if Bad then write(FNAME,' Failed !')(else write(FNAME,' Written'))
end;

```

```

BEGIN          (** MAIN PROGRAM **)
CLS;screen(4,16);write('60 DEGREE SECTOR DATA - v2.3 - ADG 16/6/87');
screen (4,1);writeLn('=====');
CLMEM; (Setting mem[8000 ] to [77])
screen(10,3);
write('Required Cycles/Block = ');
REENTER1;
screen (35,3);
read(CYCLES);writeLn(' ');
FREQ:=CYCLES*5E5/256;
screen(10,5);write('Freq. = ',FREQ/1000:2:3,' KHz, C/BK=',CYCLES:2:2,' ');
LAMBDA:=1500/FREQ;
screen(10,7);
write('Focal distance(metres) = ');
readln(F);if F=0 then goto REENTER1;
D:=F/LAMBDA;
OMEGA:= Pi*CYCLES/128;
NBbegin:=0;
REPEAT
NBbegin:=NBbegin+1;
NBend:=NBbegin;
for BLOCK:=NBbegin to NBend do
begin
screen(10,11);
write('Calculating Bearing No.=',BLOCK:2);
writeLn;
DIRECTION;
end;
BLKS:= NBend-NBbegin+1;
DECHEX; screen(1,16);
write('Writing File - ');
screen(16,16);
AUTOFILE;
until NBbegin=15
END.

```

```

Program STEERd;          (Program uses disc sides 0 & 1 )
(Flexible Transmitter   : N.L.A. Control Program      )
(Written by : A.D.Goodson : Last Mod:31/5/87         )
(Modes:          SCAN SECTOR : RIPPLE : STEER        )
(Selects +/-30 or +/-15 degrees STEERED DATA      )
(Uses: Unmodulated or NLA modulated datafiles 2-6 KHz.)
(*****
(* NOTE * Text+Code Size exceeds £8000 data boundary *)
*****
)

label RESTART2;
const A=4;B=5;C=6;D=7;
Var
  pulse                :REAL;
  pre,SAM,c,h,k,bsel,PsN,pc,repr :INTEGER;
  N,I,K,TXN,BLK,pause  :INTEGER;
  CARSEL,ALSB,AMSB,TXNS,dec :INTEGER;
  P,U,D,Hx3,Hx2,Hx1,Hx0,hexno,S1 :STRING[11];
  Char3,FF,SF          :STRING[11];
  DIR                  :STRING[4];
  MODE                 :STRING[13];
  title                :STRING[40];
  FILE,Fq              :STRING[8];
  Bad                  :BOOLEAN;

Procedure Loadmc(Var Bad:Boolean;FILE:String[8]);External #C04B;
Procedure Savemc(Var B:Boolean;S,F,E:Integer;F:String[8]);External #C04E;
Procedure CLS;Code #3E,#C,#F7;
Procedure DOS;CODE #C3,#00,#D0;(Jump to Operating System)
Procedure Drive(I:Integer);External #C048;
Procedure PAUSE; begin repeat K:=Keyboard until K<>0 end;
Procedure HEXCON; begin h:=ord(hexno)-48;if h>9 then h:=h-7 end;

Procedure CONHEX; const HEXSTRING='0123456789ABCDEF';
  begin h:=h+1;hexno:=mid(HEXSTRING,h,1) end;

Procedure DECHEX;
  begin (call with value in 'dec'.)
    h:=dec DIV 16;
    CONHEX;
    write(hexno);
    h:=dec MOD 16;
    CONHEX;
    write(hexno);
  end;

Procedure FRQa;
  begin
    Drive(1);          (30 degree sector data)
    h:=K;CONHEX;
    FILE:=concat('mc',hexno,'S',FF,'mod');
  end;

Procedure FRQb; (Constructs required Filename for bearing and frequency)
  begin
    Drive(0);          (60 degree sector data)
    h:=K;CONHEX;
    FILE:=concat('mc',hexno,'S',FF,'MOD');
  end;

Procedure INITPORT;
  begin
    out(cA,#FF);out(cA,00);
    (Sets port4 into mode3 ; all bits set as outputs)
    out(cB,#FF);out(cB,#10);
    (Sets port5 into mode3 with bit 4 as input,)
    ( others output )
  end;

Procedure DELAY; begin (now effectively removed) end;

```

```

Procedure CALCmsb;
begin hexno:=Hx3; HEXCON; c:=16*h;
      hexno:=Hx2; HEXCON; AMSB:=h+c; (Hx2 selects load address)
end;

Procedure CALClsb;
begin hexno:=Hx1; HEXCON; c:=16*h;
      hexno:=Hx0; HEXCON; ALSB:=h+c;
end;

Procedure TITLE;
begin
  if SF='S' then title:=( '30/60 degree Sector' );
  if SF='' then SF:='B';
  if SF='A' then title:=( ' 30 degree Sector' );
  if SF='B' then title:=( ' 60 degree Sector' );
CLS;screen(0,16);
  writeIn(' Flx.Tx: Steered NLA : ',title);
  screen(0,1);
  writeIn(' ===== ');
end;

Procedure CALCpulse;
begin
  pulse:=ALSB*2E-3; (0.51);
  if mid(FILE,5,1)='3' then begin pulse:=0.34; Hx1:='A';Hx0:='A';ALSB:=#AA;end;
  if mid(FILE,5,1)='5' then begin pulse:=0.408;Hx1:='C';Hx0:='C';ALSB:=#CC;end;
  pulse:=pulse*reps;
  if left(MODE,2)='RI' then pulse:=pulse*15;
end;

Procedure PRESET;
begin
  TITLE;
  CALCpulse;
  writeIn;
  screen(12,0);
  writeIn('Preset output conditions. ');
  screen(12,0);
  writeIn(' ===== ');
  screen(10,0);
  writeIn('Data Start Address. . . #',Hx3,Hx2,Hx1,Hx0);
  screen(10,0);
  if pre>175 then DIR:=' Up ' else DIR:='Down';
  screen(10,0);
  writeIn(reps, ' Modulation Blocks / Bearing');
  screen(10,0);
  writeIn('Pause Length ',pause:5,' milliseccs');
  screen(10,0);
  writeIn('Pulse Length ',pulse:4:1,' milliseccs');
  screen(10,0);
  writeIn('Operational Mode: ',MODE);
end;

Procedure DEFAULT;
begin
  out(B,#01) ;DELAY; (0000 0001)
  out(A,#FF) ;DELAY; (all RAM cards selected)
  out(B,#02) ;DELAY; (0000 0010)
  out(A,ALSB);DELAY; (LSB address set)
  out(B,#04) ;DELAY; (0000 0100)
  out(A,AMSB);DELAY; (MSB address set)
  out(B,#08) ;DELAY; (0000 1000)
  out(A,pre) ;DELAY; (U/D Prescale)
  out(B,#20) ;DELAY; (0010 0000)
  out(A,reps);DELAY; (Block repeats)
  out(B,#40) ;DELAY; (0100 0000)
  out(A,pc) ;DELAY; (Pause Length)
  out(B,#A0) ;DELAY; (1010 0000)
  out(A,TXNS);DELAY; (No.Tx.Pulses)
  PRESET;
end;

```



```

Procedure GET60;
begin
  SF:='B';      (Default loads 60 Deg.Sector)
  case Hx2 of   (NOTE angles set by data!)
    '0': Fq:='== ' ;
    'F': Fq:='+28 ' ;
    'E': Fq:='+24 ' ;
    'D': Fq:='+20 ' ;
    'C': Fq:='+16 ' ;
    'B': Fq:='+12 ' ;
    'A': Fq:='+8 ' ;
    '9': Fq:='+4 ' ;
    '8': Fq:='0 ' ;
    '7': Fq:='-4 ' ;
    '6': Fq:='-8 ' ;
    '5': Fq:='-12 ' ;
    '4': Fq:='-16 ' ;
    '3': Fq:='-20 ' ;
    '2': Fq:='-24 ' ;
    '1': Fq:='-28 ' ;
  end;
end;

Procedure GET30;
begin
  SF:='A';
  case Hx2 of
    '0': Fq:='== ' ;
    'F': Fq:='+14 ' ;
    'E': Fq:='+12 ' ;
    'D': Fq:='+10 ' ;
    'C': Fq:='+8 ' ;
    'B': Fq:='+6 ' ;
    'A': Fq:='+4 ' ;
    '9': Fq:='+2 ' ;
    '8': Fq:='0 ' ;
    '7': Fq:='-2 ' ;
    '6': Fq:='-4 ' ;
    '5': Fq:='-6 ' ;
    '4': Fq:='-8 ' ;
    '3': Fq:='-10 ' ;
    '2': Fq:='-12 ' ;
    '1': Fq:='-14 ' ;
  end;
end;

Procedure ADDR;
label REENTER3;
var HEXADDR:STRING[4];
begin
  writeln;
  write(' Enter Start Address in Hex . . . [ ]');
REENTER3:
  k:=0;
  screen(40,0);
  read(HEXADDR);
  Hx3:=mid(HEXADDR,1,1);if Hx3>'F' then k:=1;if Hx3<'9' then k:=1;
  Hx2:=mid(HEXADDR,2,1);
  Hx1:=mid(HEXADDR,3,1);
  Hx0:=mid(HEXADDR,4,1);
  CALCmsb;CALCLsb;
  if k=1 then goto REENTER3;
  out(B,104);DELAY;out(A,AMSB);DELAY; (Start Address MSB's)
  out(B,102);DELAY;out(A,ALSB);DELAY; (Start Address LSB's)
  writeln;writeln;
  writeln(' Start Address of Transmission Data #',Hx3,Hx2,Hx1,Hx0);
  if SF='A' then GET30 else GET60;
  if left(MODE,2)='ST' then MODE:=concat('STEER ',Fq);
end;

```

```

Procedure RIPSTEER;
begin
  (Default settings:- Prescaler 500 KHz - SAM -)
  ( pre:=#68 sets count down to 500 KHz)
  ( bits 0-3 = prescaler ratio ; bit 4 not used )
  ( bit 5 = STEER; RIPPLE;/SSP )
  ( bit 6 = RIPPLE;/STEER;/SSP )
  if P='P' then begin pre:= 8 ;MODE:='SECTOR SCAN' end;
  if P='R' then begin pre:=104 ;MODE:='RIPPLE FIRE' end;
  if P='S' then begin pre:= 40 ;MODE:=concat('STEERED ',Fq) end;
  out(B,#08);DELAY;out(A,pre);DELAY;
end;

Procedure PASS; (Circulate Modulation Block)
begin
  writeln;
  write ('      Block repeats/Tx.Pulse (1..255)      [...]' );
  screen(41,0);
  readln(reps);
  if reps>255 then reps:=255;
  if reps<1 then reps:=1;
  out(B,#20);DELAY;out(A,reps);DELAY;
end;

Procedure WAIT; (PLENGTH delay lookup table )
begin
  CASE pause OF
    1:pc:=#30;   5:pc:=#35;   10:pc:=#34;  50:pc:=#80;
    100:pc:=#28; 200:pc:=#2A;  300:pc:=#2E; 400:pc:=#29;
    500:pc:=#2D; 600:pc:=#2B; 1000:pc:=#18;
    2000:pc:=#1A;3000:pc:=#1E; 4000:pc:=#19;
    5000:pc:=#1D;6000:pc:=#1B;10000:pc:=#1C;
  OTHERS:pc:=0;
end;
end;

Procedure PLENGTH; (Pause between transmissions)
begin
  writeln;
  pc:=0;
  writeln('      Pause times available are:');
  writeln('      1,5,10,50,100,200,300,400,500,600 msec');
  writeln('      and 1,2,3,4,5,6,10 seconds');
  writeln;
  write('      Enter Pause Length (in milliSecs) [.....]');
  REPEAT
  screen(40,0);
  read(pause);
  WAIT;
  UNTIL pc<>0;
  writeln;
  out(B,#40);DELAY;out(A,pc);DELAY;
end;

Procedure SELECT; (Page select to load output RAM card )
begin
  case N of
    0: bsel:=1;
    1: bsel:=2;
    2: bsel:=4;
    3: bsel:=8;
    4: bsel:=16;
    5: bsel:=32;
    6: bsel:=64;
    7: bsel:=128;
  end;
  out(B,01);DELAY;out(A,bsel);out(B,06);DELAY;
  screen(5,0);
  write('Board ',N+1,' Selected > ');screen(25,0);
end;

```

```

procedure TRANSFER; (Copies Data from base memory to selected page)
begin
  TXN:=TXN*#100;
  for N:=0 to 7 do
    begin
      BLK:=N * #100;
      SELECT; (Card N)
      out(B,6); (Re-enable bridge A.)
      for I:=0 to #FF do
        begin
          mem[#A000+I+TXN]:=mem[#8000+I+BLK];
          end;
          write(N+1,' Loaded @ ',TXN);
          end;
          out(B,01);DELAY;out(A,#FF);
          out(B,0);
          end;

Procedure POSITION;
begin
  Hx2:=mid(FILE,3,1);
  hexno:=Hx2;HEXCON;TXN:=h;
end;

procedure COPY;
begin
  screen(11,4);
  write('File ',FILE,' - Loading ');
  Char3:=mid(FILE,3,1);
  hexno:=Char3;HEXCON;TXN:=h;
  screen(1,6);
  writeLn(' Block transfers from base memory @ #8000');
  writeLn(' to output RAM pages from #A000 + offset ');
  writeLn(' in increments of #100 bytes / block ');
  TRANSFER;
end;

procedure READFAIL;
begin
  screen(8,14);
  write('DISC ACCESS FAILED - NO FILE');
  PAUSE;CLS
end;

procedure SELFREQ; (Select Mod.frequency )
label REENTER4;
begin
  REENTER4: screen(2,14);
  writeLn;
  write('Enter Modulation frequency (0,2,3,4) KHz');
  screen(35,0);read(FF);
  if ord(FF)>#36 then goto REENTER4;
  if ord(FF)=#31 then goto REENTER4;
  if ord(FF)<#30 then FF:=#4';
  screen(1,0);
  write(' Selected Modulation Frequency - ',FF,' KHz ');
end;

Procedure SEQUENCE;
begin
  K:=0;
  CLS;screen(1,16);
  write('43 KHz: [A] 30 degrees sector or [B] 60 degree');screen(35,0);
  readLn(SF);
  SELFREQ;
  REPEAT;
  if SF='A' then FRQa else FRQb;
  Loadmc(Bad,FILE);if Bad then READFAIL else COPY;
  (screen(16,2);writeLn(FILE,' - Loaded ');)
  K:=K+1;
  UNTIL K>15;
  if SF='A' then GET30 else GET60;
end;

```

```

Procedure DATAIN;
label REENTER2;
begin
  write('  Load Data from Disc [Y/N or Fill mem ?]');
  screen(28,0);readln(P);CLS;(MODE:=' ');
  IF P='F' then SEQUENCE; (Fill memory with Block Sequence.)
  begin
    IF P='Y' then
      begin
REENTER2:
        begin
          writeln;
          write('      Enter Filename >mc.....<');
          screen(28,0);readln(FILE);writeln;FILE:=<concat('mc',FILE)>;
          end;
(3rd char in filename = TXN no.)
          Loadmc(Bad,FILE);
          Fq:=' '; (Blank as Bearing is unknown)
          MODE:=FILE;(Display Filename Just loaded)
          If Bad then READFAIL else COPY;
          POSITION;
          Hx3:='A';hexno:=Hx3;HEXCON;c:=16*h;AMSB:=c+TXN;
          out(B,04);DELAY;out(A,AMSB);DELAY; (Reset MSB to new file)
          writeln;
          write('  Load More Data from Disc . . . . [Y/N] ');
          screen(43,0);readln(P);
          IF P='Y' then goto REENTER2;
          end;
        end;
      end;
end;

Procedure TXSEQUENCE;
begin
  write ('  Number of Transmissions (255 max) [...]' );
  screen(41,0);readln(TXNS);
  end;

Procedure LOADPARAM;
begin
  (Loadmc(Bad,'PARAM');
  (read parameter file from disc and display)
  end;

Procedure ChPOSN;
begin
  if left(MODE,2)='SE' then Psn:=43;
  if left(MODE,2)='RI' then Psn:=39;
  if left(MODE,2)='ST' then Psn:=41
  end;

Procedure NEWPARAM;
label REENTER6;
begin
  CLS;
  TITLE;
  screen(0,4);
  ChPOSN;
  write('  Ripple / Steered / Ping Sector . [R/S/P]');
  screen(Psn,0);
  read(P);writeln;RIPSTEER;
  writeln;
  write('  Select Start Address . . . . . [Y/N]');
  screen(43,0);
  readln(P);
  IF P='Y' then ADDR      ELSE begin
  out(B,02);DELAY;out(A,ALSB);DELAY;
  out(B,04);DELAY;out(A,AMSB);DELAY;end;writeln;
  write('  Select Modulation Blocks/Pulse. . [Y/N]');
  screen(43,0);
  readln(P);
  IF P='Y' then PASS      ELSE begin
  out(B,20);DELAY;out(A,reprs);DELAY;end;writeln;

```

```

    write('    Select Pulse Repeat Rate . . . . [Y/N]');
    screen(43,0);
    readln(P);
    IF P='Y' then PLENGTH ELSE begin
    out(B, #40); DELAY; out(A, pc); DELAY; end; writeln;

    ( write('    Select Number of Transmissions . [Y/N]');
    screen(43,0); readln(P); writeln;
    IF P='Y' then TXSEQUENCE ELSE ) begin
    out(B, #A0); DELAY; out(A, TXNS); DELAY; end; writeln;
REENTER;
    PRESET;
    end;

Procedure Dosfetch; Procedure Dfcall; External #F00;
Begin init mem[#F00] to #CD,0, #D8,1, #21, #12, #F, #22, #21, #D, #CD,0, #D8, #18, #DA,0,
0, #C9, #50, #41, #53, #43, #4C, #44, #4F, #53; Dfcall; end;

Begin          (***** MAIN PROGRAM *****)
    Dosfetch; (Use in Merged code version only!)
    (Default Parameters:
    ( : O/P Bd.Select=) CARDSEL :=#FF; Hx3:= 'C'; Hx2:= 'F'; Hx1:= 'F'; Hx0:= 'F';
    ( : Start Address=) ALSB:=#FF; AMSB:=#CF;
    ( : Prescale u/d =) pre:=#68; SAM:=500;
    ( : Char Position=) Psn:=39; (RIPPLE)
    ( : Modblocks/Tx.=) reps :=#01;
    ( : Pause length =) pc :=#28; pause:=100;
    ( : No. of Tx's =) TXNS :=#FF;
    ( : Steered Mode =) MODE := 'Channel Test ' ;
    ( : Select Title =) SF:= 'S';
    TITLE;
    writeln;
    writeln('    Channel Test Mode Data from #C000-CFFF ');
    writeln; writeln;
    INITPORT; DATAIN; (Loads all 8 boards with precomputed data)
RESTART2;
    TITLE;
    (writeln('    Selected Parameters are:');
    write('    Ripple/Steer/Ping Sector . #'); dec:=pre; DECHEX; writeln;
    write('    Start Address. . . . . #'); dec:=AMSB; DECHEX; writeln;
    dec:=ALSB; DECHEX; writeln;
    write('    Modulation Blocks/Txn. . . #'); dec:=reps; DECHEX; writeln;
    write('    Period between Txn . . . . #'); dec:=pc; DECHEX; writeln;
    write('    Operational Mode . . . . ,MODE, ' ');
    writeln;);
    PRESET; screen(1,11);
    write('    Are different parameters required [Y/N] ');
    screen(43,0); readln(P);
    IF P(>'Y' then DEFAULT else NEWPARAM;
    (Select ALL RAM cards )
    out(B, #01); DELAY; out(A, #FF); DELAY; writeln;
    screen(1,11);
    write('    Ready to Transmit . . . . . ');
    PAUSE; screen (37,0);
    writeln('RUNNING');
    out(B, #80); out(B, #C0);
    PAUSE;
    out(B, #60);
    screen(1,11);
    writeln('    FINISHED (at end of TX block) ..... ');
    writeln('=====');
    writeln; write('    New.[F]ile / [R]estart / [Q]uit. ');
    screen(23,0);
    readln(P); if P='F' then CLS;
    if P='R' then DATAIN;
    if P='Q' then DOS else goto RESTART2;

End.

```

```

Program DISPLAYf;
( Author: A.D.Goodson      v.02      15/5/86  )
( Reads selected disk files and then displays  )
( start and ends of 16 channels to check phases.)
( Requires H.Graf.4 Char Gen.Chip & 16 line mod.)
( Uses mem[ $\#8000$  to  $\#8800$ ] )

var A,B:REAL;
    Bd,L,H,I,J,K,X,Z :INTEGER;
    File               :String[8];
    S                  :String[255];
    S1                 :String[1];
    Eof,Bad,Pleasedelay :Boolean;
    RE                 :Real;
    I,Sectorcount,Loop :Integer;

Procedure Loadmc(Var Bad:Boolean;File:String[8]);External  $\#C04B$ ;
Procedure CLS;Code  $\#3E$ , $\#C$ , $\#F7$ ;

procedure PARAM;
begin
  write('Enter Start Address  $\#8000$ ');
  screen(21,0);
  readln(H);if H=0 then H:= $\#8000$ ;
  write('Enter Increment    $\#100$  ');
  screen(21,0);
  readln(I);if I=0 then I:= $\#100$ ;
end;

procedure CHAR;
begin
  I:= 160-Z; (160 to 145)
  write(chr(I));
end;

procedure HI;
begin
  Z:=mem[H+((J)* $\#100$ )+K-1] MOD 16;
end;

procedure LO;
begin
  Z:=trunc(mem[H+((J)* $\#100$ )+K-1]/16)
end;

procedure PLOT;
begin
  Bd:=0;
  CLS;
  screen(1,16);
  for J:=0 to 7 do begin
    for L:=1 to 2 do begin
      Bd:=Bd+1;
      screen(1,0);
      for K:=1 to 20 do
        begin
          if odd(L) then LO else HI;
          CHAR;
        end;
      screen(21,0);write(Bd:2);screen(24,0);
      (1/2 Block)      (Full block)
      for K:=(107 to 127 do) 235 to 255 do
        begin
          if odd(L) then LO else HI;
          CHAR;
        end;
      screen(1,Bd);
    end;
  end;
end;
end;
end;

```

```

procedure PAUSE;
begin
  REPEAT UNTIL keyboard
end;

procedure TITLE;
begin
  CLS;
  screen(1,16);write('DISPLAY TX.PHASES from DISC - V1.0 - ADG15/5/85');
  screen(1,1);write('=====');
end;

Begin
  (** MAIN PROGRAM **)
  TITLE;
  Hi:=#8000;Ii:=#100;
repeat
  screen(12,10);write(' New Filename - ');screen(28,10);readln(File);
  If File='*' then CLS
  else
  begin
    Loadmc(Bad,File);
    PLOT;
    PAUSE;
  end;
until File='*'
End.

```

